



TRACKED EXCAVATOR | JS330/370 LC/NLC

Net engine power: 281 hp (210 kW) | Bucket capacity: 1.12 – 2.52 yd³ | Operating weight: 72691 – 85156 lb



DURABILITY AND RELIABILITY.

YOUR NEW EXCAVATOR NEEDS TO BE TOUGH ENOUGH TO PERFORM ANY JOB. FORTUNATELY, STRENGTH AND DURABILITY ARE STANDARD ON THE JCB JS330 AND JS370.



On the upper structure, a large storage space is available to store chains and other essential accessories. A new cover over the washer fluid bottle maximizes usable space.

Boom and dipper.

1 The reinforced boom and dipper on the JS330/370 is made of high tensile steel. Internal baffle plates and heavy-duty wear strips at the dipper end offer enhanced durability.

2 JCB's advanced manufacturing and assembly processes produce precise, high quality assembled components.



1

Componentry.

3 The JCB JS330/370 is equipped with industry-leading components, including a 6-cylinder, 281 hp MTU engine, Berco running gear, Kawasaki pumps and Kayaba main control valves.

The MTU 6-cylinder 281 hp engine uses a multi-stage fuel filtration system consisting of a remote primary filter with a built-in water separator and secondary engine-mounted filter to protect against a wide range of fuel contaminants. Standard equipment includes a fuel shut off tap and a self-priming lift pump for easy servicing.



2

We use Finite Element Analysis with extensive rig and endurance testing to make key components last longer.



3



3



The JCB JS330/370 turret is welded to both the upper and lower undercarriage frame.

Structural strength.

- 4 The JCB JS330/370 features a high-strength undercarriage based on a fully-welded X-frame for long-term durability in the most demanding of applications.
- 5 A closed box-section revolving frame increases strength and reduces stress, and is highly resistant to impact damage.
- 6 The JS330/370's high-strength, rigid upper frame provides maximum durability and support.
- 7 The stiff, durable door design provides excellent strength and rigidity.

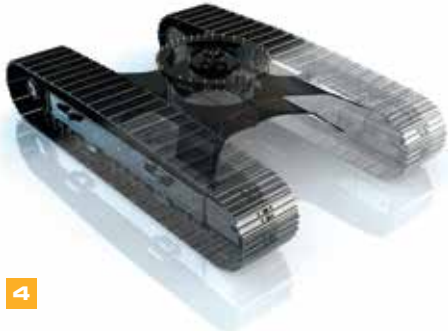

4

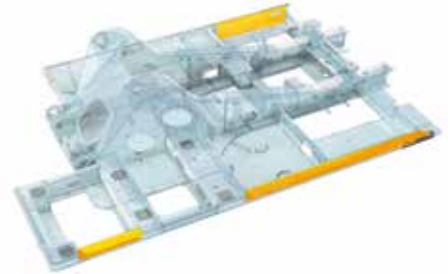

5



7



6

MAXIMUM PRODUCTIVITY, MINIMUM SPEND.

IT'S MORE IMPORTANT THAN EVER TO SAVE TIME AND MONEY; THE JCB JS330 AND JS370 IS DESIGNED TO MAKE THE MOST OF BOTH.

Efficiency.

Advanced hydraulic technology ensures that the JS330/370 starts in idle for maximum fuel efficiency, contributing to fuel savings.

1 The MTU 7.7-liter engine produces a formidable 281 hp of power and 848 lbf of torque, and works in harmony with the SMART control electronics to deliver smooth high torque power even at low RPM.

Upping output.

2 With bucket tearout up to 59,754 lbf and fast cycle times, the JS330/370 is extremely productive in all applications.

3 Simultaneous tracking and excavating is smooth and fast with an intuitive multifunction operation.

An electric fan clutch automatically adjusts the fan speed based on the cooling demands, reducing noise and fuel consumption.



1



1



2



3



To save fuel, JCB Auto-Idle technology automatically reduces engine speed when hydraulics are not in use.

Stability, hydraulics and attachments.

4 JCB's innovative hydraulic regeneration system recycles oil across the cylinders for faster cycle times and reduced fuel consumption.

5 The JCB JS330/370 features cushioned boom and dipper ends to prevent shock loadings which protects your machine and increases operator comfort.

JCB SMART Control gives access to variable working modes. The manually selectable Heavy Plus mode offers great efficiency, with 5 percent gains over outgoing models.

For ultra versatility, JCB offers a full list of auxiliary pipework options including hammer, auxiliary, merged and low-flow.



A COMFORTABLE FAVORITE.

JCB EXCAVATORS ARE DESIGNED AROUND THE OPERATOR. AFTER ALL, GREAT COMFORT AND EASE OF USE EQUALS GREAT PRODUCTIVITY.

Visibly better.

1 The JCB JS330/370 features a 70/30 split front windshield, providing excellent front visibility. A clear view of the front right track ensures easy, safe trench digging and maneuvering.

2 An innovative, low-level hood provides excellent rear visibility.

Comfortably in control.

3 The 7-inch, color, multi-function display is easy to read in all light conditions, provides instant operational information, and has a customizable home screen.

JCB's new basic tool select system (fitted as standard) allows the operator to set the flow for the the single-direction auxiliary and hammer circuit to suit attachment flow requirements. The selected flow rate is achieved by automatically adjusting the engine RPM when the hydraulic service is operated.

DEF level and usage can be checked via the in-cab LCD monitor, which features a low-level warning.



A balanced slew and electronic/hydraulic controlled slew braking ensure speed and precision.



The working environment.

4 The JS330/370 creates a quieter working environment inside and out, allowing the machine to be used at any location, any time.

JCB cabs use six viscous rubber mounts to minimize noise and vibration.

5 JCB's climate control is standard, and offers a precisely controlled cab temperature with fresh or recirculated air. Demisting/defrosting functions keep the front window clear.

6 A spacious luggage tray is located behind the operator's seat.

A large floor area with large high grip pedals and t-bar levers enables easy and precise tracking.



The JS330/370 cab and controls are independently adjustable to find the perfect operating position.

Seating options can be tailored to suit many different applications.

LESS SERVICING, MORE SERVICE.

THE JCB JS330 AND JS370 ARE DESIGNED FOR LOW MAINTENANCE AND EASY SERVICABILITY, MAKING THEM AFFORDABLE, EFFICIENT AND HIGHLY PRODUCTIVE.

JCB JS330/370 excavators are equipped with a new and improved, easy-to-clean toolbox.

Easy does it.

1 The air filter on a JS330/370 is easily accessible, and a double-element construction simplifies cleaning. The latest JCB Powercore air filter is fitted as standard for extended cleaning intervals.

2 JCB JS330/370 filters (engine oil, hydraulic oil and fuel) are centrally located for fast, easy servicing. By reducing the number of fuel filters from three to two, routine maintenance is reduced significantly.

Unlike other Tier 4 Final excavators, the JCB JS330/370 does not require a diesel particulate filter (DPF), eliminating the need for costly servicing and replacement filters. No DPF also means no regeneration cycles, which leads to improved productivity.

The diesel exhaust fluid (DEF) filling point and DEF components are easily accessible via the upper structure.



The JCB JS330/370 features graphite-impregnated bronze bushes to reduce boom and dipper greasing intervals to 1000 hours for normal applications.



SERVICE INTERVALS	
Engine oil and oil filter	Every 500 hours
Hydraulic oil	Every 5000 hours
Hydraulic oil filter	Every 1000 hours

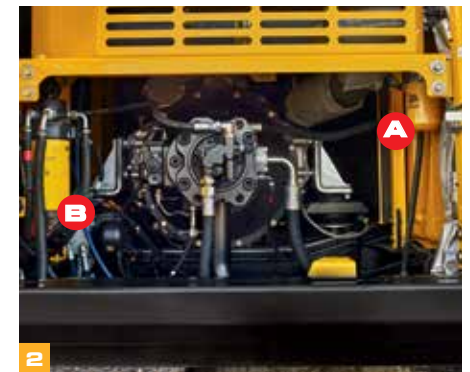

(A) Hydraulics oil filters (B) Fuel filters



The JCB JS330/370 hood opens and closes easily with gas-assisted cylinders, and the service bays are large and wide for easy access.

JCB JS330/370 grease points are centralized for safe and easy access to high-level pivots.

Here to help.

- 3 JCB's Smart Control automatically checks the engine oil and engine coolant level on machine start up.
- 4 The engine radiator, hydraulic cooler and intercooler are mounted side by side and can be serviced individually and cleaned easily.
- 5 Service your JCB JS330/370 with your local dealer and our trained engineers to minimize downtime. Order genuine JCB parts online and, in 95% of cases, they'll be with you the next day. For enhanced security, performance management and maintenance planning, opt for JCB LiveLink remote monitoring.



THE SAFE CHOICE.

ON-SITE SAFETY IS CRUCIAL. WITH THE JCB JS330/370, YOUR OPERATORS ARE IN SAFE HANDS.

A bulkhead heat shield between the pumps and the engine guards against heat and noise.



1 The JCB JS330/370 hood opens front-to-rear for easy and safe engine service access. To make operator access safer, a tread plate is installed over the engine. A fuel shut off tap provides a quick, safe way to change fuel filters and reduce the risk of spillage and contamination.



2 For extra peace of mind, JCB JS330/370 cabs are available with an optional external rollover protection system (ROPS) and falling object protection system (FOPS).

3 JCB's Safety Lever Lock fully isolates hydraulic functions to avoid unintended movements. Our 2GO system means a JCB JS330/370 can only be started in a safe locked position via two separate inputs.

4 The JCB JS330/370 has a large glass area and low hood line for superb visibility.

5 Steps and platforms on the JS330/370 have anti-slip punched steel plates for optimum grip, even in wet or icy conditions. Bolt-on plates have recessed bolts to reduce trip hazard. The reconfigured step arrangement provides a handy extra toolbox for secure storage.



6 JCB's standard rear-view and optional side-view cameras display uninterrupted views on the smart controller display.

7 JS330/370s are equipped with a full set of side and rear view mirrors as standard, providing all round visibility and safety compliance.

To reduce the risk of putting diesel in the DEF tank, the DEF and diesel tanks are color-coded, labeled differently, opened by different keys, and have different-sized nozzles.

Our factory-fit immobilizers automatically arm after a set time following shutdown, and can help reduce your insurance premiums.

JCB LiveLink telematics technology delivers essential reports on everything from vehicle usage to fuel economy, idle time and engine load data.



LIVELINK, WORK SMARTER.

LIVELINK IS AN INNOVATIVE SOFTWARE SYSTEM THAT LETS YOU MANAGE YOUR JCB MACHINES REMOTELY FROM A COMPUTER, TABLET OR SMART PHONE. ACCESS EVERYTHING FROM MACHINE ALERTS TO FUEL REPORTS AND HISTORY INFORMATION, WITH ALL DATA STORED AT A SECURE CENTER.

Productivity and cost benefits

By providing information like idle time monitoring and machine fuel consumption, JCB Livelink helps reduce your fuel usage, saving money and improving productivity. Machine location information can help improve efficiency and possibly reduce insurance costs.



Maintenance benefits

Manage machine maintenance easily – accurate hours monitoring and service alerts improve maintenance planning and real-time location data helps you manage your fleet. Critical machine alerts and maintenance history records are also available.



Security benefits

Livelink's real-time geofencing alerts let you know when machines move out of predetermined zones, and real-time curfew alerts inform you of unauthorized usage. Further benefits include real-time location information, advanced ECU matching (pairs Livelink with the immobilizer or ECU).



VALUE ADDED.

JCB PROVIDES WORLDWIDE CUSTOMER SUPPORT. WHATEVER YOU NEED AND WHEREVER YOU ARE, WE'LL BE AVAILABLE QUICKLY AND EFFICIENTLY TO HELP MAKE SURE YOUR MACHINERY IS PERFORMING TO ITS FULL POTENTIAL.



1

1 JCB Technical Support Service provides instant access to factory expertise, day or night, while our Finance and Insurance teams are always on hand to provide fast, flexible and competitive quotes.

2 The global network of JCB Parts Centers is a model of efficiency; with 16 regional bases, we can deliver around 95 percent of all parts anywhere in the world within 24 hours. Genuine JCB parts are designed to work in perfect harmony with your machine for optimum performance and productivity.



2

3 JCB Assetcare offers comprehensive extended warranties and service agreements, as well as service-only or repair and maintenance contracts.

Around the world, JCB maintenance teams provide competitive, no-obligation labor quotes and fast, efficient insurance repair work.



3

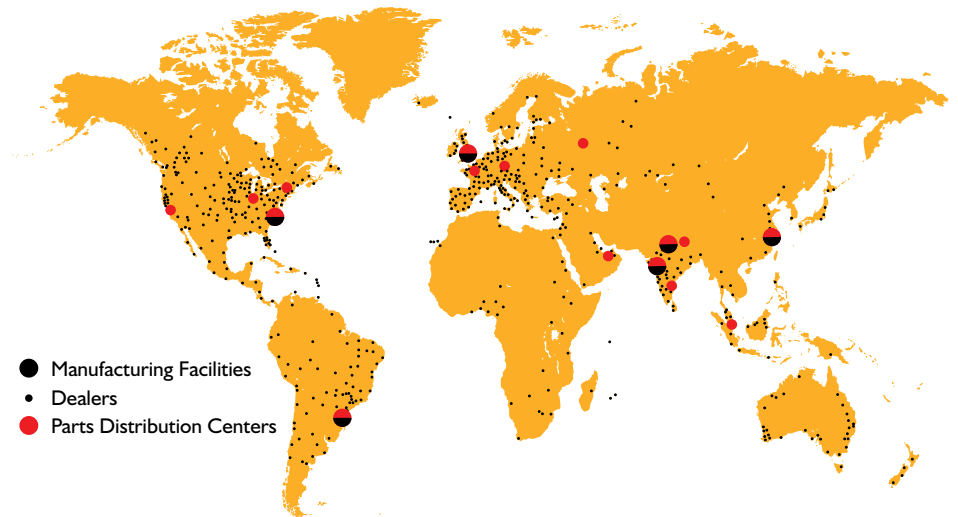

Note: JCB LIVELINK and JCB ASSETCARE may not be available in your region, so please check with your local dealer.

STATIC DIMENSIONS

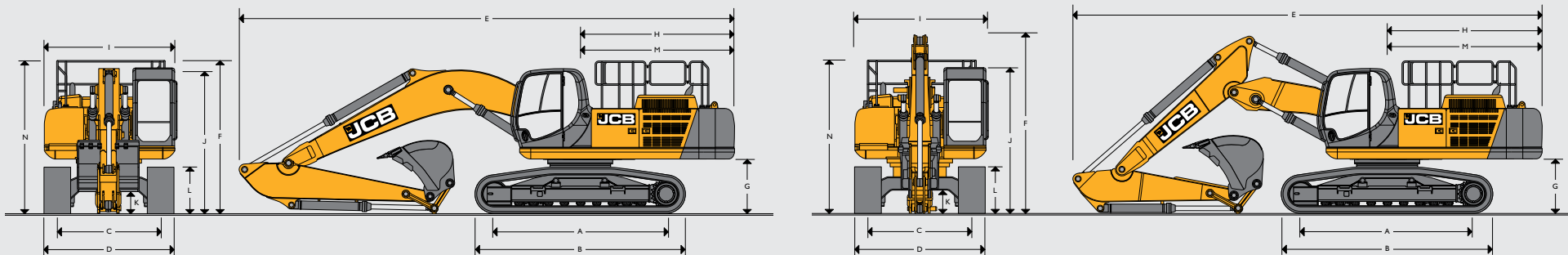

STATIC DIMENSIONS

Model		JS330 LC	JS330 NLC	JS370 LC	JS370 NLC				
A	Track length on ground	ft-in (mm)	13-0 (3965)	13-0 (3965)	13-2 (4022)				
B	Undercarriage overall length	ft-in (mm)	15-11 (4848)	15-11 (4848)	16-3 (4954)				
C	Track gauge	ft-in (mm)	8-6 (2600)	7-10 (2390)	8-6 (2600)				
D	Width over tracks (24" (600 mm trackshoes))	ft-in (mm)	10-6 (3200)	9-10 (2990)	10-6 (3200)				
D	Width over tracks (28" (700 mm trackshoes))	ft-in (mm)	10-10 (3300)	10-2 (3090)	10-10 (3300)				
D	Width over tracks (32" (800 mm trackshoes))	ft-in (mm)	11-2 (3400)	10-6 (3190)	11-2 (3400)				
D	Width over tracks (36" (900 mm trackshoes))	ft-in (mm)	11-6 (3500)	10-10 (3290)	10-10 (3290)				
G	Counterweight clearance	ft-in (mm)	3-11 (1195)	3-11 (1195)	4-0 (1215)				
H	Tail swing radius	ft-in (mm)	11-9 (3571)	11-9 (3571)	11-9 (3571)				
I	Overall width of superstructure	ft-in (mm)	9-10 (2990)	9-10 (2990)	9-10 (2990)				
J	Height over cab	ft-in (mm)	10-5 (3177)	10-5 (3177)	10-6 (3202)				
K	Ground clearance	ft-in (mm)	1-8 (506)	1-8 (506)	1-9 (530)				
L	Track height	ft-in (mm)	3-4 (1011)	3-4 (1011)	3-4 (1024)				
M	Tail length	ft-in (mm)	11-8 (3563)	11-8 (3563)	11-8 (3563)				
N	Height over grab rail	ft-in (mm)	10-11 (3335)	10-11 (3335)	11-0 (3360)				
		Monoboomb 21-2 (6.45 m)				Monoboomb 21-2 (6.45 m)			
Dipper lengths		7-3 (2.21 m)	8-8 (2.63 m)	10-7 (3.23 m)	13-3 (4.03 m)	7-3 (2.21 m)	8-8 (2.63 m)	10-7 (3.23 m)	13-3 (4.03 m)
E	Transport length	ft-in (mm)	37-4 (11382)	37-1 (11291)	36-11 (11257)	37-0 (11279)	37-7 (11448)	37-2 (11321)	36-11 (11248)
F	Transport height	ft-in (mm)	(3625)	(3591)	(3767)	(3887)	11-8 (3562)	11-0 (3360)	11-0 (3360)
		ME boom 20-0 (6.10 m)				ME boom 20-0 (6.10 m)			
Dipper lengths		7-3 (2.21 m)	8-8 (2.63 m)	7-3 (2.21 m)	8-8 (2.63 m)				
E	Transport length	ft-in (mm)	36-3 (11039)	35-11 (10946)	36-4 (11081)	36-1 (11008)			
F	Transport height	ft-in (mm)	12-0 (3662)	12-4 (3759)	12-2 (3720)	3813 (3813)			
		T.A.B. 21-2 (6.45 m)				T.A.B. 21-2 (6.45 m)			
Dipper lengths		7-3 (2.21 m)	8-8 (2.63 m)	10-7 (3.23 m)	13-3 (4.03 m)	7-3 (2.21 m)	8-8 (2.63 m)	10-7 (3.23 m)	13-3 (4.03 m)
E	Transport length	ft-in (mm)	35-3 (10755)	35-4 (10765)	35-4 (10764)	35-8 (10864)	35-8 (10877)	35-3 (10734)	36-0 (10978)
F	Transport height	ft-in (mm)	12-9 (3885)	12-8 (3870)	12-9 (3897)	12-7 (3845)	12-10 (3921)	13-3 (4041)	12-1 (3690)

ENGINE	
Model	MTU 6R1000 Tier 4 Final compliant
Type	Water cooled, 4-stroke, 6-cylinder in-line, common rail direct injection, turbocharged intercooled diesel.
Rated power (net)	210 kW (281 hp) at 1900 RPM
Piston Displacement	7.7 liters
Air Filtration	Dry element with secondary safety element and in-cab warning indicator.
Starting system	24 V
Batteries	2 x 12 V
Alternator	24 V, 100 amp

SLEW SYSTEM	
Slew motor	Axial piston type.
Slew brake	Hydraulic braking plus automatic spring applied disc type parking brake.
Slew torque	JS330: 24954 lbf (111 kNm) JS370: 29000 lbf (129 kNm)
Slew speed	JS330: 8.5 RPM JS370: 8.9 RPM
Slew gear	Large diameter, internally toothed fully sealed grease bath lubricated.

UNDERCARRIAGE	
Carriage options	LC - Long Carriage and NLC - Narrow Long Carriage.
Construction	Fully welded, 'X' frame type with central bellyguarding and sloping sidemembers with dirt relief holes under top rollers.
Recovery point	Front and rear.
Track shoe options	24", 28", 32", 36" (600 mm, 700 mm, 800 mm, 900 mm)
Upper and lower rollers	Heat treated, sealed and lubricated.
Track adjustment	Grease cylinder type.
Track idler	Sealed and lubricated, with spring cushioned recoil.
Track type	Sealed and lubricated.
No. of track guides	2 per side
No. of lower rollers (each side)	9 per side
No. of upper rollers (each side)	2 per side
No. of track shoes	JS330: 50 JS370: 48

TRACK DRIVE	
Type	Fully hydrostatic, two speed with autoshift.
Travel motors	Variable swash axial piston type, fully guarded within undercarriage frame.
Final drive	Planetary reduction, bolt-on sprockets.
Service brake	Hydraulic counter balance valve.
Park brake	Disc type, spring applied, automatic hydraulic release.
Gradeability	70% (35 deg) continuous.
Travel speed	JS330 JS370
	High – 3.2 mph (5.2 km/h) High – 3.2 mph (5.2 km/h)
	Low – 1.9 mph (3.0 km/h) Low – 1.9 mph (3.0 km/h)
Tractive effort	57550 lbf (256 kNm) 56200 lbf (250 kNm)

HYDRAULIC SYSTEM	
A variable flow negative control system with flow on demand, variable power output and servo operated, multi function open center.	
Pumps	
Main pumps	2 variable displacement axial piston type.
Maximum flow	JS330: 2 x 76.9 gpm JS370: 2 x 80.3 gpm
Servo pump	Gear type.
Maximum flow	7.5 gpm
Control valve	
A combined four and five spool control valve with auxiliary service spool as standard.	
Relief valve settings	
Boom/Arm/Bucket	4627 psi (319 bar)
With power boost	5047 psi (348 bar)
Swing circuit	JS300: 2626 psi (250 bar) JS370: 4206 psi (290 bar)
Travel circuit	5047 psi (348 bar)
Pilot control	638 psi (44 bar)
Filtration	
In tank	150 micron, suction strainer.
Main return line	10 micron, glass fibre element.
Pilot line	10 micron, paper element.
Hydraulic hammer return	10 micron, reinforced microform element.

SERVICE CAPACITIES		
Fuel tank	Gallons (Liters)	155.9 (590)
Engine coolant	Gallons (Liters)	10.3 (39)
Engine oil	Gallons (Liters)	6.6 (25)
Swing reduction gear	Gallons (Liters)	4.2 (16)
Track reduction gear (each side)	Gallons (Liters)	1.3 (5)
Hydraulic system	Gallons (Liters)	113.6 (430)
Hydraulic tank	Gallons (Liters)	63.1 (239)
DEF fluid capacity	Gallons (Liters)	12.4 (47)

STANDARD EXCAVATING BUCKETS – JS330

Bucket options	GP Bucket				HD Bucket				
	in (mm)	36 (950)	54 (1400)	60 (1550)	72 (1800)	36 (950)	54 (1400)	60 (1550)	72 (1800)
Bucket width									
Bucket capacity yd ³ (m ³)	1.12 (0.86)	1.87 (1.43)	2.12 (1.62)	2.52 (1.93)	1.12 (0.86)	1.87 (1.43)	2.12 (1.62)	2.52 (1.93)	
Bucket weight lb (kg)	1839 (834)	2332 (1058)	2524 (1145)	2815 (1277)	2039 (925)	2621 (1189)	2795 (1268)	3148 (1428)	
Monoboom 21-2 (6.45 m)									
7-3 (2.21 m)	☐	☐	☐	☐	☐	☐	☐	☐	☐
8-8 (2.63 m)	☐	☐	☐	☐	☐	☐	☐	☐	☐
10-7 (3.23 m)	☐	☐	☐	●	☐	☐	☐	●	
13-3 (4.03 m)	☐	☐	●	■	☐	☐	●	■	
ME Boom 20-0 (6.10 m)									
7-3 (2.21 m)	☐	☐	☐	☐	☐	☐	☐	☐	☐
8-8 (2.63 m)	☐	☐	☐	☐	☐	☐	☐	☐	☐
T.A.B. 21-2 (6.45 m)									
7-3 (2.21 m)	☐	☐	☐	☐	☐	☐	☐	☐	☐
8-8 (2.63 m)	☐	☐	☐	☐	☐	☐	☐	☐	☐
10-7 (3.23 m)	☐	☐	☐	●	☐	☐	☐	●	
13-3 (4.03 m)	☐	☐	●	■	☐	●	●	■	

- ☐ = Material weight up to 4400 lb/yd³ (2000 kg/m³)
- = Material weight up to 3525 lb/yd³ (1600 kg/m³)
- = Material weight up to 2650 lb/yd³ (1200 kg/m³)

These recommendations are based on an LC undercarriage fitted with 24" tracks and JCB quick hitch. They are a guide only, please contact your distributor for more information on selecting the correct attachment to suit your application(s).

WEIGHTS AND GROUND BEARING PRESSURES – JS330

Machine specified with a 10' 7" (3.23 m) dipper, 2.35 yd³ (1.8 m³) bucket, operator and full fuel tank

		24" (600 mm) shoes	28" (700 mm) shoes	32" (800 mm) shoes	36" (900 mm) shoes
JS330 LC Monoboom					
Machine weight	lb (kg)	73555 (33364)	74437 (33764)	75319 (34164)	76201 (34564)
Ground bearing pressure	psi (kg/cm ²)	9.4 (0.66)	8.1 (0.57)	7.1 (0.51)	6.4 (0.45)
JS330 NLC Monoboom					
Machine weight	lb (kg)	73246 (33224)	74128 (33624)	75010 (34024)	75892 (34424)
Ground bearing pressure	psi (kg/cm ²)	9.4 (0.66)	8.1 (0.57)	7.1 (0.50)	6.4 (0.45)
JS330 LC ME Boom					
Machine weight	lb (kg)	72999 (33112)	73881 (33512)	74763 (33912)	75645 (34312)
Ground bearing pressure	psi (kg/cm ²)	9.2 (0.65)	8.1 (0.57)	7.1 (0.50)	6.4 (0.45)
JS330 NLC ME Boom					
Machine weight	lb (kg)	72691 (32972)	73573 (33372)	74455 (33772)	75336 (34172)
Ground bearing pressure	psi (kg/cm ²)	9.2 (0.65)	8.0 (0.56)	7.1 (0.50)	6.4 (0.45)
JS330 LC T.A.B.					
Machine weight	lb (kg)	77356 (35088)	78238 (35488)	79119 (35888)	80001 (36288)
Ground bearing pressure	psi (kg/cm ²)	10.0 (0.70)	8.5 (0.60)	7.5 (0.53)	6.8 (0.48)
JS330 NLC T.A.B.					
Machine weight	lb (kg)	77047 (34948)	77292 (35348)	78811 (35748)	79693 (36148)
Ground bearing pressure	psi (kg/cm ²)	9.8 (0.69)	8.5 (0.60)	7.5 (0.53)	6.8 (0.48)

STANDARD EXCAVATING BUCKETS – JS370

Bucket options	GP Bucket				HD Bucket				
	in (mm)	36 (950)	54 (1400)	60 (1550)	72 (1800)	36 (950)	54 (1400)	60 (1550)	72 (1800)
Bucket width									
Bucket capacity yd ³ (m ³)	1.12 (0.86)	1.87 (1.43)	2.12 (1.62)	2.52 (1.93)	1.12 (0.86)	1.87 (1.43)	2.12 (1.62)	2.52 (1.93)	
Bucket weight lb (kg)	1839 (834)	2332 (1058)	2524 (1145)	2815 (1277)	2039 (925)	2621 (1189)	2795 (1268)	3148 (1428)	
Monoboom 21-2 (6.45 m)									
7-3 (2.21 m)	☐	☐	☐	☐	☐	☐	☐	☐	☐
8-8 (2.63 m)	☐	☐	☐	☐	☐	☐	☐	☐	☐
10-7 (3.23 m)	☐	☐	☐	☐	☐	☐	☐	☐	☐
13-3 (4.03 m)	☐	☐	☐	●	☐	☐	☐	●	
ME Boom 20-0 (6.10 m)									
7-3 (2.21 m)	☐	☐	☐	☐	☐	☐	☐	☐	☐
8-8 (2.63 m)	☐	☐	☐	☐	☐	☐	☐	☐	☐
T.A.B. 21-2 (6.45 m)									
7-3 (2.21 m)	☐	☐	☐	☐	☐	☐	☐	☐	☐
8-8 (2.63 m)	☐	☐	☐	☐	☐	☐	☐	☐	☐
10-7 (3.23 m)	☐	☐	☐	☐	☐	☐	☐	☐	☐
13-3 (4.03 m)	☐	☐	☐	●	☐	☐	☐	●	

- ☐ = Material weight up to 4400 lb/yd³ (2000 kg/m³)
- = Material weight up to 3525 lb/yd³ (1600 kg/m³)
- = Material weight up to 2650 lb/yd³ (1200 kg/m³)

These recommendations are based on an LC undercarriage fitted with 24" tracks and JCB quick hitch. They are a guide only, please contact your distributor for more information on selecting the correct attachment to suit your application(s).

WEIGHTS AND GROUND BEARING PRESSURES – JS370

Machine specified with a 10' 7" (3.23 m) dipper, 2.35 yd³ (1.8 m³) bucket, operator and full fuel tank

		24" (600 mm) shoes	28" (700 mm) shoes	32" (800 mm) shoes	36" (900 mm) shoes
JS370 LC Monoboom					
Machine weight	lb (kg)	80030 (36301)	81011 (36746)	81992 (37191)	82973 (37636)
Ground bearing pressure	psi (kg/cm ²)	10.0 (0.70)	8.5 (0.60)	7.5 (0.53)	6.8 (0.48)
JS370 NLC Monoboom					
Machine weight	lb (kg)	79679 (36142)	80661 (36587)	81642 (37032)	82623 (37477)
Ground bearing pressure	psi (kg/cm ²)	9.8 (0.69)	8.5 (0.60)	7.5 (0.53)	6.8 (0.48)
JS370 LC ME Boom					
Machine weight	lb (kg)	79823 (36207)	80804 (36652)	81785 (37097)	82766 (37542)
Ground bearing pressure	psi (kg/cm ²)	9.8 (0.69)	8.5 (0.60)	7.5 (0.53)	6.8 (0.48)
JS370 NLC ME Boom					
Machine weight	lb (kg)	79472 (36048)	80453 (36493)	81434 (36938)	82415 (37383)
Ground bearing pressure	psi (kg/cm ²)	9.8 (0.69)	8.5 (0.60)	7.5 (0.53)	6.8 (0.48)
JS370 LC T.A.B.					
Machine weight	lb (kg)	82213 (37291)	83194 (37736)	84175 (38181)	85156 (38626)
Ground bearing pressure	psi (kg/cm ²)	10.2 (0.72)	8.8 (0.62)	7.8 (0.55)	7.0 (0.49)
JS370 NLC T.A.B.					
Machine weight	lb (kg)	81862 (37132)	82843 (37577)	83824 (38022)	84805 (38467)
Ground bearing pressure	psi (kg/cm ²)	10.1 (0.71)	8.8 (0.62)	7.8 (0.55)	7.0 (0.49)

JS330 WORKING RANGE – MONOBOOM 2I-2 (6.45 M)

Dipper length:		7-3 (2.21 m)	8-8 (2.63 m)	10-7 (3.23 m)	13-3 (4.03 m)	
A	Maximum digging reach	ft-in (mm)	33-1 (10083)	34-5 (10492)	36-7 (11150)	38-8 (11777)
B	Maximum digging reach (on ground)	ft-in (mm)	32-5 (9876)	33-9 (10288)	36-0 (10967)	38-1 (11596)
C	Maximum digging depth	ft-in (mm)	20-7 (6278)	22-0 (6705)	24-0 (7303)	26-7 (8101)
D	Maximum digging height	ft-in (mm)	31-7 (9626)	32-4 (9857)	34-6 (10507)	34-4 (10457)
E	Maximum dumping height	ft-in (mm)	22-4 (6797)	23-0 (7003)	24-9 (7552)	24-10 (7557)
F	Maximum vertical wall cut depth	ft-in (mm)	16-2 (4928)	18-1 (5517)	21-11 (6691)	23-1 (7027)
G	Minimum swing radius	ft-in (mm)	15-4 (4673)	15-3 (4638)	14-11 (4554)	14-10 (4521)
	Bucket rotation	degrees	185	185	185	185
	Maximum dipper tearout	lbf (kNm)	46625 (207.4)	40713 (181.1)	33834 (150.5)	29315 (130.4)
	Maximum bucket tearout	lbf (kNm)	51931 (231.0)	51931 (231.0)	51931 (231.0)	51931 (231.0)

JS330 WORKING RANGE – T.A.B. 2I-2 (6.45 M)

Dipper length:		7-3 (2.21 m)	8-8 (2.63 m)	10-7 (3.23 m)	13-3 (4.03 m)	
A	Maximum digging reach	ft-in (mm)	33-5 (10181)	34-9 (10599)	36-8 (11181)	39-1 (11922)
B	Maximum digging reach (on ground)	ft-in (mm)	32-9 (9973)	34-1 (10399)	36-1 (10991)	38-6 (11744)
C	Maximum digging depth	ft-in (mm)	19-1 (5812)	20-6 (6240)	22-5 (6837)	25-0 (7618)
D	Maximum digging height	ft-in (mm)	37-10 (11530)	39-0 (11893)	40-8 (12389)	42-7 (12968)
E	Maximum dumping height	ft-in (mm)	27-7 (8419)	28-9 (8772)	30-5 (9263)	32-3 (9841)
F	Maximum vertical wall cut depth	ft-in (mm)	14-11 (4552)	16-6 (5036)	18-8 (5681)	21-8 (6616)
G	Minimum swing radius	ft-in (mm)	9-11 (3022)	10-1 (3086)	9-7 (2909)	10-10 (3311)
	Bucket rotation	degrees	185	185	185	185
	Maximum dipper tearout	lbf (kNm)	46625 (207.4)	40713 (181.1)	33834 (150.5)	29315 (130.4)
	Maximum bucket tearout	lbf (kNm)	51931 (231.0)	51931 (231.0)	51931 (231.0)	51931 (231.0)

JS330 WORKING RANGE – ME BOOM 20-0 (6.10 M)

Dipper length:		7-3 (2.21 m)	8-8 (2.63 m)	
A	Maximum digging reach	ft-in (mm)	32-1 (9778)	33-5 (10184)
B	Maximum digging reach (on ground)	ft-in (mm)	31-4 (9558)	32-9 (9978)
C	Maximum digging depth	ft-in (mm)	19-5 (5923)	20-11 (6375)
D	Maximum digging height	ft-in (mm)	31-5 (9573)	32-2 (9816)
E	Maximum dumping height	ft-in (mm)	22-0 (6695)	22-8 (6911)
F	Maximum vertical wall cut depth	ft-in (mm)	16-1 (4895)	18-0 (5488)
G	Minimum swing radius	ft-in (mm)	14-1 (4298)	14-2 (4327)
	Bucket rotation	degrees	185	185
	Maximum dipper tearout	lbf (kNm)	46625 (207.4)	40713 (181.1)
	Maximum bucket tearout	lbf (kNm)	51931 (231.0)	51931 (231.0)

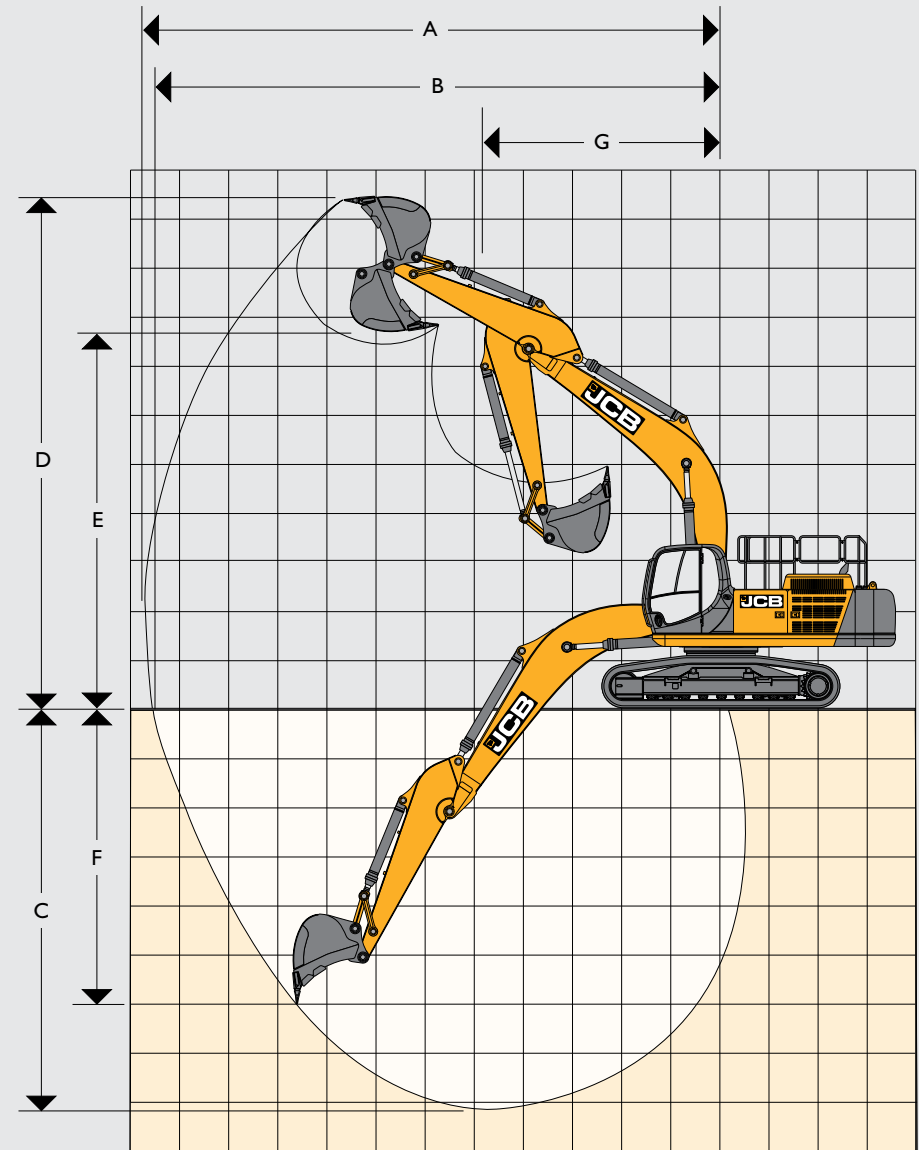

JS370 WORKING RANGE – MONOBOOM 2I-2 (6.45 M)

Dipper length:		7-3 (2.21 m)	8-8 (2.63 m)	10-7 (3.23 m)	13-3 (4.03 m)	
A	Maximum digging reach	ft-in (mm)	33-1 (10079)	34-5 (10485)	36-2 (11023)	38-7 (11770)
B	Maximum digging reach (on ground)	ft-in (mm)	32-4 (9863)	33-8 (10269)	35-6 (10826)	38-0 (11586)
C	Maximum digging depth	ft-in (mm)	20-6 (6260)	21-11 (6690)	23-11 (7288)	26-6 (8084)
D	Maximum digging height	ft-in (mm)	31-5 (9584)	32-2 (9808)	33-1 (10094)	34-2 (10414)
E	Maximum dumping height	ft-in (mm)	22-3 (6789)	22-11 (6983)	23-9 (7245)	24-9 (7555)
F	Maximum vertical wall cut depth	ft-in (mm)	15-7 (4747)	17-6 (5325)	19-10 (6041)	22-7 (6880)
G	Minimum swing radius	ft-in (mm)	15-7 (4738)	15-6 (4714)	15-0 (4571)	15-1 (4608)
	Bucket rotation	degrees	185	185	185	185
	Maximum dipper tearout	lbf (kNm)	55258 (245.8)	48289 (214.8)	40106 (178.4)	34463 (153.3)
	Maximum bucket tearout	lbf (kNm)	59754 (265.8)	59754 (265.8)	59754 (265.8)	59754 (265.8)

JS370 WORKING RANGE – T.A.B. 2I-2 (6.45 M)

Dipper length:		7-3 (2.21 m)	8-8 (2.63 m)	10-7 (3.23 m)	13-3 (4.03 m)	
A	Maximum digging reach	ft-in (mm)	33-5 (10177)	34-8 (10570)	36-6 (11136)	39-2 (11935)
B	Maximum digging reach (on ground)	ft-in (mm)	32-8 (9963)	34-0 (10364)	35-11 (10942)	38-7 (11754)
C	Maximum digging depth	ft-in (mm)	19-0 (5784)	20-5 (6211)	22-4 (6808)	24-11 (7595)
D	Maximum digging height	ft-in (mm)	38-0 (11581)	39-1 (11909)	40-3 (12266)	42-9 (13035)
E	Maximum dumping height	ft-in (mm)	27-9 (8451)	28-11 (8823)	30-1 (9162)	32-6 (9904)
F	Maximum vertical wall cut depth	ft-in (mm)	14-11 (4535)	16-6 (5017)	18-7 (5665)	21-2 (6463)
G	Minimum swing radius	ft-in (mm)	10-1 (3073)	10-5 (3165)	9-10 (2994)	11-0 (3353)
	Bucket rotation	degrees	185	185	185	185
	Maximum dipper tearout	lbf (kNm)	55258 (245.8)	48289 (214.8)	40106 (178.4)	34463 (153.3)
	Maximum bucket tearout	lbf (kNm)	59754 (265.8)	59754 (265.8)	59754 (265.8)	59754 (265.8)

JS370 WORKING RANGE – ME BOOM 20-0 (6.10 M)

Dipper length:		7-3 (2.21 m)	8-8 (2.63 m)	
A	Maximum digging reach	ft-in (mm)	32-0 (9761)	33-4 (10168)
B	Maximum digging reach (on ground)	ft-in (mm)	30-10 (9388)	32-8 (9954)
C	Maximum digging depth	ft-in (mm)	19-6 (5932)	20-10 (6360)
D	Maximum digging height	ft-in (mm)	24-6 (7459)	32-0 (9752)
E	Maximum dumping height	ft-in (mm)	16-2 (4924)	22-7 (6878)
F	Maximum vertical wall cut depth	ft-in (mm)	15-5 (4704)	17-4 (5284)
G	Minimum swing radius	ft-in (mm)	19-6 (5939)	14-5 (4396)
	Bucket rotation	degrees	185	185
	Maximum dipper tearout	lbf (kNm)	55258 (245.8)	48289 (214.8)
	Maximum bucket tearout	lbf (kNm)	59754 (265.8)	59754 (265.8)

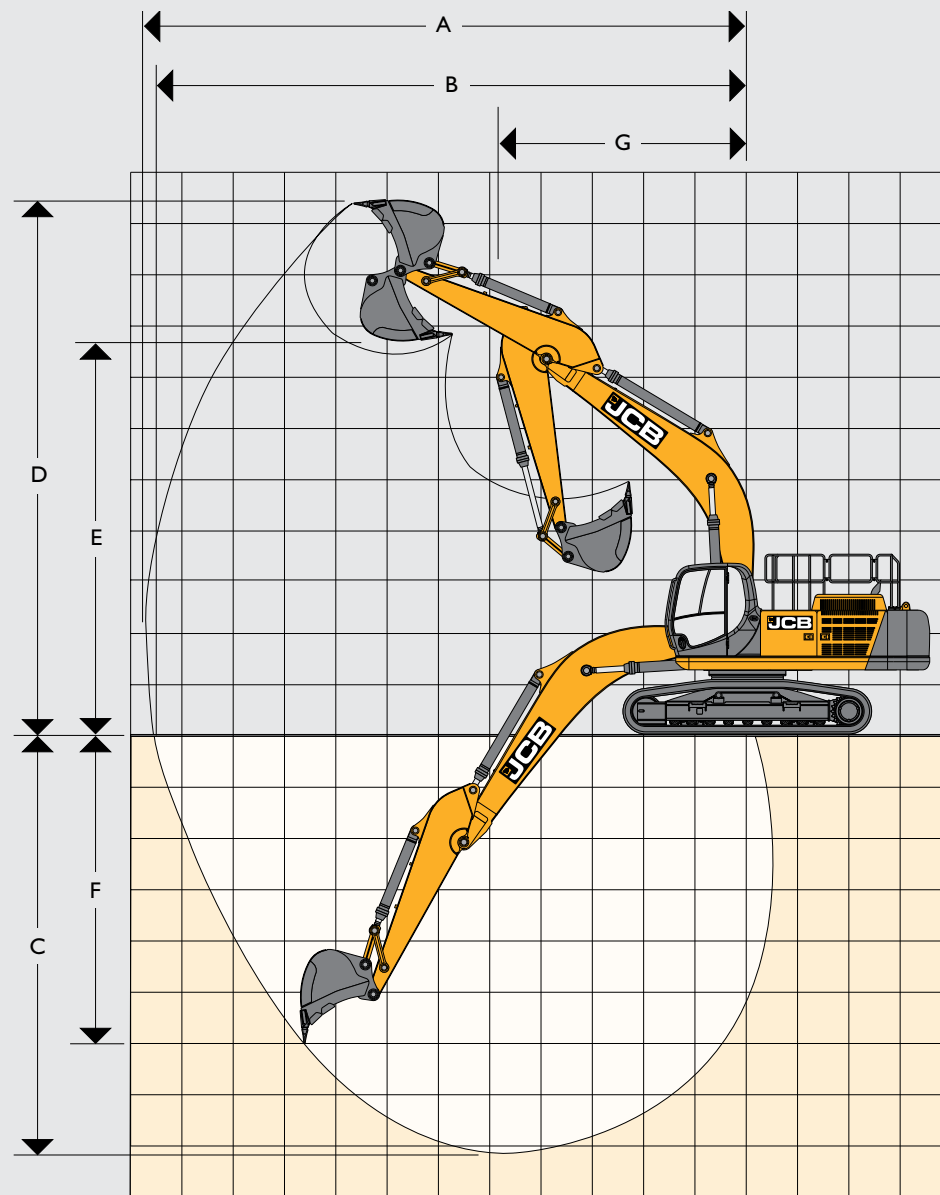

STANDARD/OPTIONAL EQUIPMENT

ENGINE	
MTU, Stage IV compliant, SCR, EGR, DOC, water-cooled diesel engine with Fixed Turbo Charger and air-to-air intercooler	•
Start pre-heat	•
DEF tank	•
One touch idle	•
Auto-idle function	•
No DPF	•
Refuelling pump	•
Fan guard	•
Heavy duty batteries	•
Fuel filter with water separator	•
Fuel shutoff tap	•
Electronic engine control	•
Fuel cooler	•
Scavenge air filter	+
SAFETY	
Side guard rails on upper structure and steps	•
Rear-view camera	•
Battery isolator	•
Key	•
2 GO	•
Lockable fuel cap	•
Work lights (1 main frame, 2 boom mounted, 1 counterweight)	•
Additional work lights (2 cab mounted)	+
LED worklight upgrade	+
FOPS II guards – top and front	+
Demolition cage (FOPS level II)	XD only
Side-view camera	+
Travel alarm	+
White noise travel alarm	+
Green beacon linked seat belt	+
Fire extinguisher	+
Vandal guards	+
Chevron counterweight	+
Roll Over Protective Structure (ROPS)	+
Boom and arm cylinder safety valves & overload warning	+
Rear counterweight safety handrails	+
Rotating beacon	+
2 x counterweight beacons	+















CAB & INTERIOR	
Sound-insulated and 6 shock mounted cab	•
Mechanical suspension seat	•
Air conditioning with climate control	•
Opening front window and removable lower front window	•
Sliding left window	•
Upper windscreen wiper	•
3 button joysticks	•
Travel pedals and T hand levers	•
Immobilizer	•
Loudspeakers and connections for radio	•
Standard cab filtration	•
Electric horn	•
Interior cab light	•
12 V power socket	•
7" color monitor	•
Retractable 2" seat belt	•
3" seat belt	+
Full length front blind	+
Half length front blind	+
Heated, adjustable air suspension seat with adjustable headrest and armrest	+
Lower windscreen wiper	+
Radio	+
Carbon air filter	+
Deluxe seat	+
Rain visor	+
UNDERCARRIAGE	
24", 28", 32", 36" triple grouser shoe	+
Narrow undercarriage	+
Greased and sealed track links	•
Twin track guards	•
Full length track guards (JS370 only)	XD only
DIG END	
No lift tipping link	•
Dippers: 8' 2", 10' 2", 12' 2"	+
XD Dipper: 8' 2", 10' 2", 12' 2"	XD only
Lifting hook t/link	+
Lifting shackle t/link	+
Bucket ram guards	+
Triple Articulating Boom (TAB)	+
Mass Excavation boom (ME)	+
Long reach rig: 12330 mm boom, 9500 mm dipper	+

HYDRAULIC SYSTEM	
Boom and arm flow regeneration	•
One-touch power boost function	•
Boom/slew priority control	•
Cushion control	•
Cylinder cushioning and contamination seals	•
Oil cooler	•
Control of auxiliary hydraulic flow and pressure from display panel with I/O tool setting storage	+
High and low flow aux options	+
Bio oil	+
Panolin oil	+
Quick hitch pipework	+
Hydraulic hitch	+
ISO/SAE changeover	+
Quick release couplings	+
Hose burst check valves	+
Breaker piping	+
Shut off taps	+















OTHER	
Livelink telematics	•
10 mm heavy-duty upper and lower belly plates	+
Side impact protection	+
Fly screens	+
Tracked tool kit	+
Guards for work lights	+

STANDARD •
OPTIONAL +















LIFT CAPACITIES – Dipper length: 7' 3" (2.21 m), Boom: 21' 2" (6.45 m), Trackshoes: 24" (600 mm) triple grouser. JS330 LC MONO

Load Point	Reach from Swing Center														Max Reach	
	4' 11" (1.5 m)		9' 10" (3 m)		14' 9" (4.5 m)		19' 8" (6 m)		24' 7" (7.5 m)		29' 6" (9 m)					
Height															ft-in (mm)	
24' 7" (7.5 m)								19048* (8640*)	19048* (8640*)					18915* (8580*)	17857 (8100)	21-3 (6491)
19' 8" (6 m)								19753* (8960*)	19753* (8960*)	18166* (8240*)	13911 (6310)			18166* (8240*)	13823 (6270)	24-7 (7523)
14' 9" (4.5 m)					28638* (12990*)	28638* (12990*)	21826* (9900*)	19048 (8640)	18673* (8470*)	13602 (6170)			17571 (7970)	11883 (5390)	26-7 (8151)	
9' 10" (3 m)							24251* (11000*)	17967 (8150)	19577 (8880)	13095 (5940)			16248 (7370)	10913 (4950)	27-8 (8467)	
4' 11" (1.5 m)							25926* (11760*)	17130 (7770)	19070 (8650)	12632 (5730)			15873 (7200)	10604 (4810)	27-9 (8506)	
0' 0" (0 m)					34612* (15700*)	25287 (11470)	26102 (11840)	16711 (7580)	18783 (8520)	12368 (5610)			16358 (7420)	10869 (4930)	27-1 (8273)	
-4' 11" (-1.5 m)					32099* (14560*)	25419 (11530)	25000 (11340*)	16645 (7550)	18783 (8520)	12368 (5610)			17990 (8160)	11883 (5390)	25-4 (7741)	
-9' 10" (-3 m)			32650* (14810*)	32650* (14810*)	27668* (12550*)	25860 (11730)	21649 (9820)	16593 (7690)					18056* (8190*)	14286 (6480)	22-4 (6842)	
-14' 9" (-4.5 m)					19445* (8820*)	19445* (8820*)							15807* (7170*)	15807* (7170*)	17-7 (5388)	

LIFT CAPACITIES – Dipper length: 8' 8" (2.63 m), Boom: 21' 1" (6.45 m), Trackshoes: 24" (600 mm) triple grouser. JS330 LC MONO

Load Point	Reach from Swing Center														Max Reach	
	4' 11" (1.5 m)		9' 10" (3 m)		14' 9" (4.5 m)		19' 8" (6 m)		24' 7" (7.5 m)		29' 6" (9 m)					
Height															ft-in (mm)	
24' 7" (7.5 m)														17549* (7960*)	15939 (7230)	23-0 (7008)
19' 8" (6 m)								18805* (8530*)	18805* (8530*)	17218* (7810*)	14176 (6430)			17020* (7720*)	12721 (5770)	26-2 (7972)
14' 9" (4.5 m)					26894* (12240*)	26894* (12240*)	20988* (9520*)	19400 (8800)	18034* (8180*)	13779 (6250)			16358 (7420)	11089 (5030)	28-1 (8567)	
9' 10" (3 m)					32672* (14820*)	27337 (12400)	23567* (10690*)	18276 (8290)	19246* (8730*)	13250 (6010)			15234 (6910)	10251 (4650)	29-1 (8867)	
4' 11" (1.5 m)					31151* (14130*)	25750 (11680)	25573* (11600*)	17350 (7870)	19202 (8710)	12743 (5780)			14903 (6760)	9965 (4520)	29-2 (8905)	
0' 0" (0 m)					35428* (16070*)	25265 (11460)	26213* (11890)	16799 (7620)	18827 (8540)	12412 (5630)			15300 (6940)	10185 (4620)	28-5 (8682)	
-4' 11" (-1.5 m)			26014* (11800*)	26014* (11800*)	33378* (15140*)	25309 (11480)	25529* (11580*)	16645 (7550)	18717 (8490)	12324 (5590)			16623 (7540)	11023 (5000)	26-8 (8178)	
-9' 10" (-3 m)			37037* (16800*)	37037* (16800*)	29498* (13380*)	25684 (11650)	22906* (10390*)	16843 (7640)					17527* (7950*)	12919 (5860)	24-1 (7334)	
-14' 9" (-4.5 m)			24646* (12540*)	24646* (12540*)	22531* (10220*)	22531* (10220*)	16270* (7380*)	16270* (7380*)					16248* (7370*)	16248* (7370*)	19-7 (6004)	

LIFT CAPACITIES – Dipper length: 10' 7" (3.23 m), Boom: 21' 2" (6.45 m), Trackshoes: 24" (600 mm) triple grouser. JS330 LC MONO



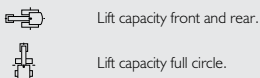











Load Point	Reach from Swing Center														Max Reach	
	4' 11" (1.5 m)		9' 10" (3 m)		14' 9" (4.5 m)		19' 8" (6 m)		24' 7" (7.5 m)		29' 6" (9 m)					
Height															ft-in (mm)	
24' 7" (7.5 m)										14859* (6740*)	14506 (6580)			12213* (5540*)	12213* (5540*)	25-3 (7713)
19' 8" (6 m)										15895* (7210*)	14396 (6530)			11795* (5350*)	11332 (5140)	28-2 (8597)
14' 9" (4.5 m)							19467* (8830*)	16467* (8830*)	16931* (7680*)	13933 (6320)	14418* (6540*)	10318 (4680)		11795* (5350*)	10009 (4540)	30-0 (9150)
9' 10" (3 m)					30247* (13720*)	28109 (12750)	22266* (10100*)	18497 (8390)	18342* (8320*)	13316 (6040)	14925 (6770)	10053 (4560)	12191* (5530*)	9303 (4220)	30-9 (9432)	
4' 11" (1.5 m)					34458* (15630*)	26125 (11850)	24669* (11190*)	17438 (7910)	19202 (8710)	12473 (5780)	14616 (6630)	9766 (4430)	12985* (5890*)	9039 (4100)	31-1 (9467)	
0' 0" (0 m)					35626* (16160*)	25243 (11450)	25970* (11780*)	16755 (7600)	18739 (8500)	12324 (5590)	14396 (6530)	9568 (4340)	13823 (6270)	9193 (4170)	30-4 (9258)	
-4' 11" (-1.5 m)			25794* (11700*)	25794* (11700*)	34502* (15650*)	25022 (11350)	25838 (11720)	16468 (7470)	18519 (8400)	12125 (5500)			14837 (6730)	9833 (4460)	28-8 (8788)	
-9' 10" (-3 m)			40807* (18510*)	40807* (18510*)	31460* (14270*)	25243 (11450)	24030* (10900*)	16512 (7490)	18475* (8380*)	12191 (5530)			16557* (7510*)	11221 (5090)	26-3 (8009)	
-14' 9" (-4.5 m)			33598* (15240*)	33598* (15240*)	25838* (11720*)	25838* (11720*)	15977* (8880*)	16593 (7690)					16027* (7270*)	14330 (6500)	22-4 (6815)	

















Notes:

1. For lifting capacity including bucket, subtract total weight of bucket or bucket and quickhitch from above values.
2. Lifting capacities are based on ISO 10567, that is: 75% of minimum tipping load or 87% of hydraulic lift capacity, whichever is the less. Lifting capacities marked* are based on hydraulic capacity.
3. Lift capacities assume that the machine is on firm, level ground.
4. Lift capacities may be limited by local regulations. Please refer to your dealer.















LIFT CAPACITIES – Dipper length: 13' 3" (4.03 m), Boom: 21' 2" (6.45 m), Trackshoes: 24" (600 mm) triple grouser. JS330 LC MONO

Load Point	Reach from Swing Center														Max Reach	
	4' 11" (1.5 m)		9' 10" (3 m)		14' 9" (4.5 m)		19' 8" (6 m)		24' 7" (7.5 m)		29' 6" (9 m)					
Height															ft-in (mm)	
24' 7" (7.5 m)														10031* (4550*)	10031* (4550*)	28-2 (8586)
19' 8" (6 m)										14374* (6520*)	14374* (6520*)	13206* (5990*)	10869 (4930)	9766* (4430*)	9766* (4430*)	30-8 (9387)
14' 9" (4.5 m)										15609* (7080*)	14374 (6520)	14440* (6550*)	10648 (4830)	9810* (4450*)	8995 (4080)	32-5 (9895)
9' 10" (3 m)						27139* (12310*)	27139* (12310*)	20613* (9350*)	19202 (8710)	17240* (7820*)	13713 (6220)	15212 (6900)	10318 (4680)	10119* (4590*)	8422 (3820)	33-3 (10156)
4' 11" (1.5 m)					32474* (14730*)	27161 (12320)	23479* (10650*)	17990 (8160)	18849* (8550*)	13073 (5930)	14837 (6730)	9943 (4510)	10736* (4870*)	8179 (3710)	33-4 (10189)	
0' 0" (0 m)			16292* (7390*)	16292* (7390*)	35207* (15970*)	25728 (11670)	25441* (11540*)	17108 (7760)	18982 (8610)	12522 (5680)	14506 (6580)	9656 (4380)	11751* (5330*)	8267 (3750)	32-8 (9995)	
-4' 11" (-1.5 m)	16160* (7330*)	16160* (7330*)	24427* (11080*)	24427* (11080*)	35450* (16080*)	25132 (11400)	26014* (11800)	16601 (7530)	18607 (8440)	12191 (5530)	14308 (6490)	9480 (4300)	13139 (5960)	8730 (3960)	31-4 (9562)	
-9' 10" (-3 m)	25265* (11460*)	25265* (11460*)	35053* (15900*)	35053* (15900*)	33620* (15250*)	25110 (11390)	25221* (11440*)	16446 (7460)	18497 (8390)	12081 (5480)			14683 (6660)	9722 (4410)	29-0 (8853)	
-14' 9" (-4.5 m)	36001* (16330*)	36001* (16330*)	40587* (18410*)	40587* (18410*)	29520* (13390*)	25485 (11560)	22377* (10150*)	16667 (7560)	16755* (7600*)	12324 (5590)			15587* (7070*)	11751 (5330)	25-6 (7792)	

LIFT CAPACITIES – Dipper length: 7' 3" (2.21 m), Boom: 21' 2" (6.45 m), Trackshoes: 24" (600 mm) triple grouser. JS330 NLC MONO

Load Point	Reach from Swing Center														Max Reach	
	4' 11" (1.5 m)		9' 10" (3 m)		14' 9" (4.5 m)		19' 8" (6 m)		24' 7" (7.5 m)		29' 6" (9 m)					
Height															ft-in (mm)	
24' 7" (7.5 m)								19048* (8640*)	18783 (8520)					18915* (8580*)	16402 (7440)	21-3 (6491)
19' 8" (6 m)								19753* (8960*)	18342 (8320)	18166 (8240)	12765 (5790)			18166 (8240)	12676 (5750)	24-7 (7523)
14' 9" (4.5 m)					28638* (12990*)	26433 (11990)		21826* (9900*)	17416 (7900)	18673* (8470*)	12456 (5650)			17505 (7940)	10869 (4930)	26-7 (8151)
9' 10" (3 m)								24251* (11000*)	16358 (7420)	19489 (8840)	11949 (5420)			16182 (7340)	9965 (4520)	27-8 (8467)
4' 11" (1.5 m)								25926* (11760*)	15542 (7050)	19004 (8620)	11508 (5220)			15807 (7170)	9656 (4380)	27-9 (8506)
0' 0" (0 m)					34612* (15700*)	22685 (10290)		25992 (11790)	15124 (6860)	18695 (8480)	11243 (5100)			16292 (7390)	9899 (4490)	27-1 (8273)
-4' 11" (-1.5 m)					32099* (14560*)	22818 (10350)		25000* (11340*)	15079 (6840)	18695 (8480)	11243 (5100)			17901 (8120)	10825 (4910)	25-4 (7741)
-9' 10" (-3 m)			32650* (14810*)	32650* (14810*)	27668* (12550*)	23529 (10550)		21649* (9820*)	15366 (6970)					18056* (8190*)	12985 (5890)	22-4 (6842)
-14' 9" (-4.5 m)					19445* (8820*)	19445* (8820*)								15807* (7170*)	15807* (7170*)	17-7 (5388)

LIFT CAPACITIES – Dipper length: 8' 8" (2.63 m), Boom: 21' 2" (6.45 m), Trackshoes: 24" (600 mm) triple grouser. JS330 NLC MONO



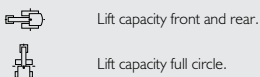











Load Point	Reach from Swing Center														Max Reach	
	4' 11" (1.5 m)		9' 10" (3 m)		14' 9" (4.5 m)		19' 8" (6 m)		24' 7" (7.5 m)		29' 6" (9 m)					
Height															ft-in (mm)	
24' 7" (7.5 m)														17549* (7960*)	14661 (6650)	23-0 (7008)
19' 8" (6 m)									18805* (8530*)	18695 (8480)	17218* (7810*)	13007 (5900)		17020* (7720*)	11684 (5300)	26-2 (7972)
14' 9" (4.5 m)					26984* (12240*)	26984* (12240*)		20988* (9520*)	17747 (8050)	18034* (8180*)	12632 (5730)			16292 (7390)	10141 (4600)	28-1 (8567)
9' 10" (3 m)					32672* (14820*)	24669 (11190)		23567* (10690*)	16667 (7560)	19246* (8730*)	12125 (5500)			15168 (6880)	9370 (4250)	29-1 (8867)
4' 11" (1.5 m)					31151* (14130*)	23126 (10490)		25573* (11600*)	15763 (7150)	19136 (8680)	11618 (5270)			14837 (6730)	9083 (4120)	29-2 (8905)
0' 0" (0 m)					35428* (16070*)	22663 (10280)		26102* (11840)	15234 (6910)	18761 (8510)	11288 (5120)			15234 (6910)	9259 (4200)	28-5 (8682)
-4' 11" (-1.5 m)			26014* (11800*)	26014* (11800*)	33378* (15140*)	22707 (10300)		25529* (11580*)	15079 (6840)	18651 (8460)	11199 (5080)			16535 (7500)	10031 (4550)	26-8 (8178)
-9' 10" (-3 m)			37037* (16800*)	37037* (16800*)	29498* (13380*)	23082 (10470)		22906* (10390*)	15256 (6920)					17527* (7950*)	11773 (5340)	24-1 (7334)
-14' 9" (-4.5 m)			27646* (12540*)	24646* (12540*)	22531* (10220*)	22531* (10220*)		16270* (7380*)	15961 (7240)					16248* (7370*)	15961 (7240)	19-7 (6004)

















Notes:

1. For lifting capacity including bucket, subtract total weight of bucket or bucket and quickhitch from above values.
2. Lifting capacities are based on ISO 10567, that is: 75% of minimum tipping load or 87% of hydraulic lift capacity, whichever is the less. Lifting capacities marked* are based on hydraulic capacity.
3. Lift capacities assume that the machine is on firm, level ground.
4. Lift capacities may be limited by local regulations. Please refer to your dealer.















LIFT CAPACITIES – Dipper length: 10' 7" (3.23 m), Boom: 21' 2" (6.45 m), Trackshoes: 24" (600 mm) triple grouser. JS330 NLC MONO

Load Point	Reach from Swing Center														Max Reach	
	4' 11" (1.5 m)		9' 10" (3 m)		14' 9" (4.5 m)		19' 8" (6 m)		24' 7" (7.5 m)		29' 6" (9 m)					
Height															ft-in (mm)	
24' 7" (7.5 m)										14859* (6740*)	13360 (6060)			12213* (5540*)	12213* (5540*)	25-3 (7713)
19' 8" (6 m)										15895* (7210*)	13228 (6000)			11795* (5350*)	10406 (4720)	28-2 (8597)
14' 9" (4.5 m)							19467* (8830*)	18034 (8180)	16931* (7680*)	12765 (5790)	14418* (6540*)	9436 (4280)	11795* (5350*)	9149 (4150)	30-0 (9150)	
9' 10" (3 m)					30247* (13720*)	25419 (11530)	22266* (10100*)	16865 (7650)	18342* (8320*)	12169 (5520)	14859 (6740)	9171 (4160)	12191* (5530*)	8488 (3850)	30-9 (9432)	
4' 11" (1.5 m)					34458* (15630*)	23479 (10650)	24669* (11190*)	15851 (7190)	19136 (8680)	11618 (5270)	14550 (6600)	8907 (4040)	12985* (5890*)	8223 (3730)	31-1 (9467)	
0' 0" (0 m)					35626* (16160*)	22641 (10270)	25970* (11780*)	15168 (6880)	18651 (8460)	11199 (5080)	14330 (6500)	8686 (3940)	14154 (6420)	8355 (3790)	30-4 (9258)	
-4' 11" (-1.5 m)			25794* (11700*)	25794* (11700*)	34502* (15650*)	22443 (10180)	25728* (11670)	14881 (6750)	18430 (8360)	11001 (4990)			14771 (6700)	8929 (4050)	28-8 (8788)	
-9' 10" (-3 m)			40807* (18510*)	40807* (18510*)	31460* (14270*)	22641 (10270)	24030* (10900*)	14925 (6770)	18475* (8380*)	11067 (5020)			16557* (7510*)	10207 (4630)	26-3 (8009)	
-14' 9" (-4.5 m)			33598* (15240*)	33598* (15240*)	25838* (11720*)	23236 (10540)	19577* (8880*)	15366 (6970)					16027* (7270*)	13029 (5910)	22-4 (6815)	

LIFT CAPACITIES – Dipper length: 13' 3" (4.03 m), Boom: 21' 2" (6.45 m), Trackshoes: 24" (600 mm) triple grouser. JS330 NLC MONO

Load Point	Reach from Swing Center														Max Reach	
	4' 11" (1.5 m)		9' 10" (3 m)		14' 9" (4.5 m)		19' 8" (6 m)		24' 7" (7.5 m)		29' 6" (9 m)					
Height															ft-in (mm)	
24' 7" (7.5 m)														10031* (4550*)	10031* (4550*)	28-2 (8586)
19' 8" (6 m)										14374* (6520*)	13713 (6220)	13206* (5990*)	9965 (4520)	9766* (4430*)	9193 (4170)	30-8 (9387)
14' 9" (4.5 m)										15609* (7080*)	13206 (5990)	14440* (6550*)	9766 (4430)	9810* (4450*)	8223 (3730)	32-5 (9895)
9' 10" (3 m)					27139* (12310*)	26852 (12180)	20613* (9350*)	17549 (7960)	17240* (7820*)	12566 (5700)	15168 (6880)	9436 (4280)	10119* (4590*)	7672 (3480)	33-3 (10156)	
4' 11" (1.5 m)					32474* (14730*)	24493 (11110)	23479* (10650*)	16380 (7430)	18849* (8550*)	11927 (5410)	14771 (6700)	9083 (4120)	10736* (4870*)	7452 (3380)	33-4 (10189)	
0' 0" (0 m)			16292* (7390*)	16292* (7390*)	35207* (15970*)	23104 (10480)	25441* (11540*)	15498 (7030)	18893 (8570)	11398 (5170)	14440 (6550)	8774 (3980)	11751* (5330*)	7518 (3410)	32-8 (9995)	
-4' 11" (-1.5 m)	16160* (7330*)	16160* (7330*)	24427* (11080*)	24427* (11080*)	35450* (16080*)	22531 (10220)	25904* (11750)	15013 (6810)	18519 (8400)	11067 (5020)	14242 (6460)	8598 (3900)	13095 (5940)	7915 (3590)	31-4 (9562)	
-9' 10" (-3 m)	25265* (11460*)	25265* (11460*)	35053* (15900*)	35053* (15900*)	33620* (15250*)	22509 (10210)	25221* (11440*)	14881 (6750)	18430 (8360)	10979 (4980)			14616 (6630)	8818 (4000)	29-0 (8853)	
-14' 9" (-4.5 m)	36001* (16330*)	36001* (16330*)	40587* (18410*)	40587* (18410*)	29520* (13390*)	22884 (10380)	22377* (10150*)	15079 (6840)	16755* (7600*)	11199 (5080)			15587* (7070*)	10692 (4850)	25-6 (7792)	

LIFT CAPACITIES – Dipper length: 7' 3" (2.21 m), Boom: 20' 0" (6.10 m), Trackshoes: 24" (600 mm) triple grouser. JS330 LC ME



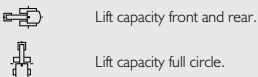











Load Point	Reach from Swing Center														Max Reach
	4' 11" (1.5 m)		9' 10" (3 m)		14' 9" (4.5 m)		19' 8" (6 m)		24' 7" (7.5 m)		29' 6" (9 m)				
Height															ft-in (mm)
24' 7" (7.5 m)							20415* (9260*)	20415* (9260*)					20437* (9270*)	20437* (9270*)	19-9 (6073)
19' 8" (6 m)							20459* (9280*)	20459* (9280*)					19400* (8800*)	15498 (7030)	23-5 (7166)
14' 9" (4.5 m)					28307* (12840*)	28307* (12840*)	22222* (10080*)	19885 (9020)	19356* (8780*)	14131 (6410)			19048* (8640*)	13184 (5980)	25-7 (7824)
9' 10" (3 m)							24493* (11110*)	18871 (8560)	20194* (9160*)	13691 (6210)			17857 (8100)	12081 (5480)	26-7 (8152)
4' 11" (1.5 m)							26169* (11870*)	18034 (8180)	19863 (9010)	13272 (6020)			17460 (7920)	11751 (5330)	26-9 (8193)
0' 0" (0 m)					35318* (16020*)	26521 (12030)	26477* (12010*)	17571 (7970)	19577 (8880)	13029 (5910)			18056 (8190)	12081 (5480)	26-1 (7950)
-4' 11" (-1.5 m)			34215* (15520*)	34215* (15520*)	32518* (14750*)	26632 (12080)	25000* (11340*)	17527 (7950)					19158* (8690*)	13338 (6050)	24-3 (7396)
-9' 10" (-3 m)			33135* (15030*)	33135* (15030*)	27271* (12370*)	27117 (12300)	20701* (9390*)	17901 (8120)					18364* (8330*)	16336 (7410)	21-2 (6447)

















Notes:

- Lifting capacities are based on ISO 10567, that is: 75% of minimum tipping load or 87% of hydraulic lift capacity, whichever is the less. Lifting capacities marked* are based on hydraulic capacity.
- Lift capacities assume that the machine is on firm, level ground.
- Lift capacities may be limited by local regulations. Please refer to your dealer.















LIFT CAPACITIES – Dipper length: 8' 8" (2.63 m), Boom: 20' 0" (6.10 m), Trackshoes: 24" (600 mm) triple grouser. JS330 LC ME

Load Point	Reach from Swing Center														Max Reach	
	4' 11" (1.5 m)		9' 10" (3 m)		14' 9" (4.5 m)		19' 8" (6 m)		24' 7" (7.5 m)		29' 6" (9 m)					
																
Height	lb (kg)	lb (kg)	lb (kg)	lb (kg)	lb (kg)	lb (kg)	lb (kg)	lb (kg)	lb (kg)	lb (kg)	lb (kg)	lb (kg)	lb (kg)	lb (kg)	ft-in (mm)	
24' 7" (7.5 m)							18783* (8520*)	18783* (8520*)						16953* (7690*)	16953* (7690*)	21-7 (6614)
19' 8" (6 m)							19290* (8750*)	19290* (8750*)	18078* (8200*)	14506 (6580)				16027* (7270*)	14087 (6390)	25-0 (7629)
14' 9" (4.5 m)					26587* (12060*)	26587* (12060*)	21230* (9630*)	20106 (9120)	18541* (8410*)	14242 (6460)				15917* (7220*)	12169 (5520)	27-1 (8248)
9' 10" (3 m)					32165* (14590*)	28880 (13100)	23699* (10750*)	19048 (8640)	19599* (8890*)	13757 (6240)				16380* (7430*)	11221 (5090)	28-1 (8561)
4' 11" (1.5 m)					35604* (16150*)	27183 (12330)	25706* (11660*)	18144 (8230)	19863 (9010)	6658 (3020)				16226 (7360)	10913 (4950)	28-2 (8599)
0' 0" (0 m)					35825* (16250*)	26521 (12030)	26455* (12000*)	17593 (7980)	19511 (8850)	12963 (5880)				16711 (7580)	11177 (5070)	27-5 (8369)
-4' 11" (-1.5 m)			32915* (14930*)	32915* (14930*)	33708* (15290*)	26477 (12010)	25529* (11580*)	17416 (7900)	19445 (8820)	12897 (5850)				18210* (8260*)	12191 (5530)	25-7 (7844)
-9' 10" (-3 m)			37500* (17010*)	37500* (17010*)	29211* (13250*)	26852 (12180)	22244* (10090*)	17637 (8000)						17769* (8060*)	14550 (6600)	22-8 (6958)
-14' 9" (-4.5 m)					20591* (9340*)	20591* (9340*)								15587* (7070*)	15587* (7070*)	18-2 (5536)

LIFT CAPACITIES – Dipper length: 7' 3" (2.21 m), Boom: 20' 0" (6.10 m), Trackshoes: 24" (600 mm) triple grouser. JS330 NLC ME

Load Point	Reach from Swing Center														Max Reach	
	4' 11" (1.5 m)		9' 10" (3 m)		14' 9" (4.5 m)		19' 8" (6 m)		24' 7" (7.5 m)		29' 6" (9 m)					
																
Height	lb (kg)	lb (kg)	lb (kg)	lb (kg)	lb (kg)	lb (kg)	lb (kg)	lb (kg)	lb (kg)	lb (kg)	lb (kg)	lb (kg)	lb (kg)	lb (kg)	ft-in (mm)	
24' 7" (7.5 m)							20415* (9260*)	19224 (8720)						20437* (9270*)	18827 (8540)	19-9 (6073)
19' 8" (6 m)							20459* (9280*)	19026 (8630)						19400* (8800*)	14220 (6450)	23-5 (7166)
14' 9" (4.5 m)					28307* (12840*)	27888 (12650)	22222* (10080*)	18210 (8260)	19356* (8780*)	12941 (5870)				19048* (8640*)	12081 (5480)	25-7 (7824)
9' 10" (3 m)							24493* (11110*)	17196 (7800)	20194* (9160*)	12522 (5680)				17791 (8070)	11045 (5010)	26-7 (8152)
4' 11" (1.5 m)							26169* (11870*)	16380 (7430)	19775 (8970)	12103 (5490)				17372 (7880)	10714 (4860)	26-9 (8193)
0' 0" (0 m)					35318* (16020*)	23810 (10800)	26477* (12010*)	15939 (7230)	19511 (8850)	11861 (5380)				17990 (8160)	11023 (5000)	26-1 (7950)
-4' 11" (-1.5 m)			34215* (15520*)	34215* (15520*)	32518* (14750*)	23920 (10850)	25000* (11340*)	15873 (7200)						19158* (8690*)	12147 (5510)	24-3 (7396)
-9' 10" (-3 m)			33135* (15030*)	33135* (15030*)	27271* (12370*)	24405 (11070)	20701* (9390*)	16248 (7370)						18364* (8330*)	14859 (6740)	21-2 (6447)

LIFT CAPACITIES – Dipper length: 8' 8" (2.63 m), Boom: 20' 0" (6.10 m), Trackshoes: 24" (600 mm) triple grouser. JS330 NLC ME

Load Point	Reach from Swing Center														Max Reach	
	4' 11" (1.5 m)		9' 10" (3 m)		14' 9" (4.5 m)		19' 8" (6 m)		24' 7" (7.5 m)		29' 6" (9 m)					
																
Height	lb (kg)	lb (kg)	lb (kg)	lb (kg)	lb (kg)	lb (kg)	lb (kg)	lb (kg)	lb (kg)	lb (kg)	lb (kg)	lb (kg)	lb (kg)	lb (kg)	ft-in (mm)	
24' 7" (7.5 m)							18733* (8520*)	18783* (8520*)						16953* (7690*)	16446 (7460)	21-7 (6614)
19' 8" (6 m)							19290 (8750)	19246 (8730)	18078* (8200*)	13316 (6040)				16027* (7270*)	12919 (5860)	25-0 (7629)
14' 9" (4.5 m)					26587* (12060*)	26587* (12060*)	21230* (9630*)	18408 (8350)	18541* (8410*)	13051 (5920)				15917* (7220*)	11133 (5050)	27-1 (8248)
9' 10" (3 m)					32165* (14590*)	26080 (11830)	23699* (10750*)	17372 (7880)	19599* (8890*)	12566 (5700)				16380* (7430*)	10251 (4650)	28-1 (8561)
4' 11" (1.5 m)					35604* (16150*)	24449 (11090)	25706* (11660*)	16490 (7480)	19775 (8970)	12103 (5490)				16138 (7320)	9943 (4510)	28-2 (8599)
0' 0" (0 m)					35825* (16250*)	23810 (10800)	26455* (12000*)	15939 (7230)	19445 (8820)	11795 (5350)				16623 (7540)	10185 (4620)	27-5 (8369)
-4' 11" (-1.5 m)			32915* (14930*)	32915* (14930*)	33708* (15290*)	23788 (10790)	25529* (11580*)	15785 (7160)	19378 (8790)	11728 (5320)				18210* (8260*)	11111 (5040)	25-7 (7844)
-9' 10" (-3 m)			37500* (17010*)	37500* (17010*)	29211* (13250*)	24140 (10950)	22244* (10090*)	16005 (7260)						17769* (8060*)	13228 (6000)	22-8 (6958)
-14' 9" (-4.5 m)					20591* (9340*)	20591* (9340*)								15587* (7070*)	15587* (7070*)	18-2 (5536)

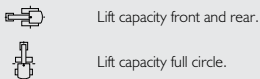

Notes:

- Lifting capacities are based on ISO 10567, that is: 75% of minimum tipping load or 87% of hydraulic lift capacity, whichever is the less. Lifting capacities marked* are based on hydraulic capacity.
- Lift capacities assume that the machine is on firm, level ground.
- Lift capacities may be limited by local regulations. Please refer to your dealer.

LIFT CAPACITIES – Dipper length: 7' 3" (2.21 m), Boom: 20' 0" (6.10 m), Trackshoes: 24" (600 mm) triple grouser.

JS330 LC T.A.B.

Load Point	Reach from Swing Center														ft-in (mm)	
	4' 11" (1.5 m)		9' 10" (3 m)		14' 9" (4.5 m)		19' 8" (6 m)		24' 7" (7.5 m)		29' 6" (9 m)		Max Reach			
Height	lb (kg)	lb (kg)	lb (kg)	lb (kg)	lb (kg)	lb (kg)	lb (kg)	lb (kg)	lb (kg)	lb (kg)	lb (kg)	lb (kg)	lb (kg)	lb (kg)	lb (kg)	
24' 7" (7.5 m)					28307* (12840*)	28307* (12840*)	23677* (10740*)	19136 (8680)						22553* (10230*)	16116 (7310)	21-7 (6613)
19' 8" (6 m)					30291* (13740*)	29365 (13320)	24118* (10940*)	18651 (8460)	20525* (9310*)	12941 (5870)				20216 (9170)	12544 (5690)	25-0 (7628)
14' 9" (4.5 m)					33730* (15300*)	26830 (12170)	25309* (11480*)	17659 (8010)	20481 (9290)	12610 (5720)				17549 (7960)	10803 (4900)	27-1 (8248)
9' 10" (3 m)							26257* (11910*)	16557 (7510)	19908 (9030)	12103 (5490)				16270 (7380)	9943 (4510)	28-1 (8560)
4' 11" (1.5 m)							25948* (11770*)	15719 (7130)	19423 (8810)	11662 (5290)				15939 (7230)	9678 (4390)	28-2 (8599)
0' 0" (0 m)							23832* (10810*)	15344 (6960)	18585* (8430*)	11420 (5180)				15190* (6890*)	9943 (4510)	27-5 (8368)
-4' 11" (-1.5 m)					22663* (10280*)	22663* (10280*)	19753* (8960*)	15344 (6960)	14771* (6700*)	11486 (5210)				13007* (5900*)	10913 (4950)	25-7 (7844)

LIFT CAPACITIES – Dipper length: 7' 3" (2.21 m), Boom: 21' 2" (6.45 m), Trackshoes: 24" (600 mm) triple grouser.

JS330 NLC T.A.B.

Load Point	Reach from Swing Center														ft-in (mm)	
	4' 11" (1.5 m)		9' 10" (3 m)		14' 9" (4.5 m)		19' 8" (6 m)		24' 7" (7.5 m)		29' 6" (9 m)		Max Reach			
Height	lb (kg)	lb (kg)	lb (kg)	lb (kg)	lb (kg)	lb (kg)	lb (kg)	lb (kg)	lb (kg)	lb (kg)	lb (kg)	lb (kg)	lb (kg)	lb (kg)	lb (kg)	
24' 7" (7.5 m)					23807* (12840*)	28307* (12840*)	23677* (10740*)	20878 (9470)						22553* (10230*)	17593 (7980)	21-7 (6613)
19' 8" (6 m)					30291* (13740*)	30291* (13740*)	24118* (10940*)	20393 (9250)	20525* (9310*)	14154 (6420)				20282* (9200*)	13713 (6220)	25-0 (7628)
14' 9" (4.5 m)					33730* (15300*)	29674 (13460)	25309* (11480*)	19356 (8780)	20569 (9330)	13823 (6270)				17615 (7990)	11839 (5370)	27-1 (8248)
9' 10" (3 m)							26257* (11910*)	18232 (8270)	19996 (9070)	13294 (6030)				16358 (7420)	10935 (4960)	28-1 (8560)
4' 11" (1.5 m)							25948* (11770*)	17394 (7890)	19489 (8840)	12853 (5830)				16005 (7260)	10648 (4830)	28-2 (8599)
0' 0" (0 m)							23832* (10810*)	16997 (7710)	18585* (8430*)	12610 (5720)				15190* (6890*)	10957 (4970)	27-5 (8368)
-4' 11" (-1.5 m)					22663* (10280*)	22663* (10280*)	19753* (8960*)	16997 (7710)	14771* (6700*)	12654 (5740)				13007* (5900*)	12015 (5450)	25-7 (7844)

LIFT CAPACITIES – Dipper length: 7' 3" (2.21 m), Boom: 21' 2" (6.45 m), Trackshoes: 24" (600 mm) triple grouser.

JS370 LC MONO

Load Point	Reach from Swing Center														ft-in (mm)	
	4' 11" (1.5 m)		9' 10" (3 m)		14' 9" (4.5 m)		19' 8" (6 m)		24' 7" (7.5 m)		29' 6" (9 m)		Max Reach			
Height	lb (kg)	lb (kg)	lb (kg)	lb (kg)	lb (kg)	lb (kg)	lb (kg)	lb (kg)	lb (kg)	lb (kg)	lb (kg)	lb (kg)	lb (kg)	lb (kg)	lb (kg)	
24' 7" (7.5 m)							22024* (9990*)	22024* (9990*)						21870* (9920*)	20371 (9240)	21-3 (6498)
19' 8" (6 m)							22884* (10380*)	22796 (10340)	21032* (9540*)	15895 (7210)				21010* (9530*)	15807 (7170)	24-7 (7523)
14' 9" (4.5 m)					33113* (15020*)	33113* (15020*)	25265* (11460*)	21639 (9840)	21627* (9810*)	15520 (7040)				20679 (9380)	13602 (6170)	26-7 (8146)
9' 10" (3 m)							28020* (12710*)	20459 (9280)	22818* (10350*)	14947 (6780)				19158 (8690)	12522 (5680)	27-7 (8457)
4' 11" (1.5 m)							29938* (13580*)	19511 (8850)	22421 (10170)	14440 (6550)				18717 (8490)	12169 (5520)	27-9 (8492)
0' 0" (0 m)					39859* (18080*)	28770 (13050)	30291* (13740*)	19026 (8630)	22090 (10020)	14131 (6410)				19312 (8760)	12478 (5660)	27-1 (8253)
-4' 11" (-1.5 m)					26927* (16750*)	28946 (13130)	28836* (13080*)	18982 (8610)	22090 (10020)	14131 (6410)				21274 (9650)	13669 (6200)	25-3 (7715)
-9' 10" (-3 m)			37522* (17020*)	37522* (17020*)	31790* (14420*)	29476 (13370)	24934* (11310*)	19334 (8770)						20966 (9510)	16424 (7450)	22-3 (6806)
-14' 9" (-4.5 m)					22266* (10100*)	22266* (10100*)								18364* (8330*)	18364* (8330*)	17-5 (5334)

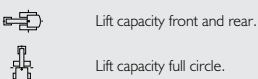





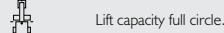









Notes:















- Lifting capacities are based on ISO 10567, that is: 75% of minimum tipping load or 87% of hydraulic lift capacity, whichever is the less. Lifting capacities marked* are based on hydraulic capacity.
- Lift capacities assume that the machine is on firm, level ground.
- Lift capacities may be limited by local regulations. Please refer to your dealer.

















LIFT CAPACITIES – Dipper length: 8' 8" (2.63 m), Boom: 21' 2" (6.45 m), Trackshoes: 24" (600 mm) triple grouser. JS370 LC MONO

Load Point	Reach from Swing Center														Max Reach		
	4' 11" (1.5 m)		9' 10" (3 m)		14' 9" (4.5 m)		19' 8" (6 m)		24' 7" (7.5 m)		29' 6" (9 m)						
Height															ft-in (mm)		
24' 7" (7.5 m)															20216* (9170*)	18166 (8240)	23-0 (7006)
19' 8" (6 m)															19643* (8910*)	14484 (6570)	26-1 (7965)
14' 9" (4.5 m)															19180 (8700)	12632 (5730)	28-1 (8555)
9' 10" (3 m)															17857 (8100)	11662 (5290)	29-0 (8852)
4' 11" (1.5 m)															17460 (7920)	11354 (5150)	29-1 (8884)
0' 0" (0 m)															17945 (8140)	11596 (5260)	28-4 (8657)
-4' 11" (-1.5 m)															19533 (8860)	12544 (5690)	26-7 (8146)
-9' 10" (-3 m)															20282* (9200*)	14749 (6690)	23-9 (7292)
-14' 9" (-4.5 m)															18805* (8530*)	18805* (8530*)	19-5 (5945)

LIFT CAPACITIES – Dipper length: 10' 7" (3.23 m), Boom: 21' 2" (6.45 m), Trackshoes: 24" (600 mm) triple grouser. JS370 LC MONO

Load Point	Reach from Swing Center														Max Reach		
	4' 11" (1.5 m)		9' 10" (3 m)		14' 9" (4.5 m)		19' 8" (6 m)		24' 7" (7.5 m)		29' 6" (9 m)						
Height															ft-in (mm)		
24' 7" (7.5 m)															14616* (6630*)	14616 (6630)	25-3 (7704)
19' 8" (6 m)															14131* (6410*)	12897 (5850)	28-2 (8584)
14' 9" (4.5 m)															14176* (6430*)	11376 (5160)	30-0 (9134)
9' 10" (3 m)															14683* (6660*)	10582 (4800)	30-9 (9412)
4' 11" (1.5 m)															11045 (5010)	10273 (4660)	31-0 (9443)
0' 0" (0 m)															16226 (7360)	10450 (4740)	30-3 (9229)
-4' 11" (-1.5 m)															17416 (7900)	11177 (5070)	28-7 (8753)
-9' 10" (-3 m)															19136* (8680*)	12809 (5810)	26-1 (7965)
-14' 9" (-4.5 m)															18585* (8430*)	16424 (7450)	22-2 (6757)

LIFT CAPACITIES – Dipper length: 13' 3" (4.03 m), Boom: 21' 2" (6.45 m), Trackshoes: 24" (600 mm) triple grouser. JS370 LC MONO



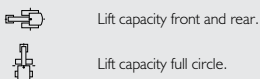











Load Point	Reach from Swing Center														Max Reach		
	4' 11" (1.5 m)		9' 10" (3 m)		14' 9" (4.5 m)		19' 8" (6 m)		24' 7" (7.5 m)		29' 6" (9 m)						
Height															ft-in (mm)		
24' 7" (7.5 m)															11376* (5160*)	11376* (5160*)	28-2 (8601)
19' 8" (6 m)															11045* (5010*)	11045* (5010*)	30-8 (9396)
14' 9" (4.5 m)															11067* (5020*)	9899 (4490)	32-5 (9900)
9' 10" (3 m)															11398* (5170*)	9237 (4190)	33-3 (10157)
4' 11" (1.5 m)															12103* (5490*)	8973 (4070)	33-4 (10185)
0' 0" (0 m)															13206* (5990*)	9039 (4100)	32-8 (9988)
-4' 11" (-1.5 m)															15057 (6830)	9546 (4330)	31-3 (9549)
-9' 10" (-3 m)															16843 (7640)	10670 (4840)	29-0 (8835)
-14' 9" (-4.5 m)															17482* (7930*)	12985 (5890)	25-5 (7766)

















Notes:

- Lifting capacities are based on ISO 10567, that is: 75% of minimum tipping load or 87% of hydraulic lift capacity, whichever is the less. Lifting capacities marked* are based on hydraulic capacity.
- Lift capacities assume that the machine is on firm, level ground.
- Lift capacities may be limited by local regulations. Please refer to your dealer.















LIFT CAPACITIES – Dipper length: 7' 3" (2.21 m), Boom: 21' 2" (6.45 m), Trackshoes: 24" (600 mm) triple grouser. JS370 NLC MONO

Load Point	Reach from Swing Center														Max Reach	
	4' 11" (1.5 m)		9' 10" (3 m)		14' 9" (4.5 m)		19' 8" (6 m)		24' 7" (7.5 m)		29' 6" (9 m)					
Height	 lb (kg)	 lb (kg)	 lb (kg)	 lb (kg)	 lb (kg)	 lb (kg)	 lb (kg)	 lb (kg)	 lb (kg)	 lb (kg)	 lb (kg)	 lb (kg)	 lb (kg)	 lb (kg)	ft-in (mm)	
24' 7" (7.5 m)								22024* (9990*)	21473 (9740)					21870* (9920*)	18717 (8490)	21-3 (6498)
19' 8" (6 m)								22884* (10380*)	20944 (9500)	21032* (9540*)	14594 (6620)			21010* (9530*)	14528 (6590)	24-7 (7523)
14' 9" (4.5 m)					33113* (15020*)	30049 (13630)		25265* (11460*)	19841 (9000)	21627* (9810*)	14242 (6460)			20635 (9360)	12478 (5660)	26-7 (8146)
9' 10" (3 m)								28020* (12710*)	18269 (8450)	22818* (10350*)	13669 (6200)			19092 (8660)	11442 (5190)	27-7 (8457)
4' 11" (1.5 m)								29938* (13580*)	17703 (8030)	22355 (10140)	13161 (5970)			18673 (8470)	11089 (5030)	27-9 (8492)
0' 0" (0 m)					39859* (18080*)	25838 (11720)		30291* (13740*)	17240 (7820)	22024 (9990)	12853 (5830)			19268 (8740)	11376 (5160)	27-1 (8253)
-4' 11" (-1.5 m)					36927* (16750*)	25992 (11790)		28836* (13080*)	17196 (7800)	22046 (10000)	12875 (5840)			21208 (9620)	12434 (5640)	25-3 (7715)
-9' 10" (-3 m)			37522* (17020*)	37522* (17020*)	31790* (14420*)	26499 (12020)		24934* (11310*)	17549 (7960)					20966* (9510*)	14969 (6790)	22-3 (6806)
-14' 9" (-4.5 m)					22266* (10100*)	22266* (10100*)								18364* (8330*)	18364* (8330*)	17-5 (5334)

LIFT CAPACITIES – Dipper length: 8' 8" (2.63 m), Boom: 21' 2" (6.45 m), Trackshoes: 24" (600 mm) triple grouser. JS370 NLC MONO

Load Point	Reach from Swing Center														Max Reach	
	4' 11" (1.5 m)		9' 10" (3 m)		14' 9" (4.5 m)		19' 8" (6 m)		24' 7" (7.5 m)		29' 6" (9 m)					
Height	 lb (kg)	 lb (kg)	 lb (kg)	 lb (kg)	 lb (kg)	 lb (kg)	 lb (kg)	 lb (kg)	 lb (kg)	 lb (kg)	 lb (kg)	 lb (kg)	 lb (kg)	 lb (kg)	ft-in (mm)	
24' 7" (7.5 m)														20216* (9170*)	16777 (7580)	23-0 (7006)
19' 8" (6 m)								21627* (9810*)	21186 (9610)	19841* (9000*)	14771 (6700)			19643* (8910*)	13316 (6040)	25-1 (7965)
14' 9" (4.5 m)					31041* (14080*)	30181 (13690)		24162* (10960*)	20084 (9110)	20767* (9420*)	14330 (6500)			19136 (8680)	11552 (5240)	28-1 (8555)
9' 10" (3 m)					37633* (17070*)	27888 (12650)		27117* (12300*)	18827 (8540)	22156* (10050*)	13713 (6220)			17813 (8080)	10670 (4840)	29-0 (8852)
4' 11" (1.5 m)								29409* (13340*)	17813 (8080)	22377 (10150)	13139 (5960)			17416 (7900)	10340 (4690)	29-1 (8884)
0' 0" (0 m)					40697* (18460*)	25728 (11670)		30225* (13710*)	17218 (7810)	21958 (9960)	12765 (5790)			17901 (8120)	10560 (4790)	28-4 (8657)
-4' 11" (-1.5 m)			31394* (14240*)	31394* (14240*)	38316* (17380*)	25772 (11690)		39321* (13300*)	17064 (7740)	21826 (9900)	12676 (5750)			19489 (8840)	11420 (5180)	26-7 (8146)
-9' 10" (-3 m)			42461* (19260*)	42461* (19260*)	33797* (15330*)	26169 (11870)		26235* (11900*)	17284 (7840)					20282* (9200*)	13426 (6090)	23-9 (7292)
-14' 9" (-4.5 m)					25662* (11640*)	25662* (11640*)								18805* (8530*)	18320 (8310)	19-5 (5945)

LIFT CAPACITIES – Dipper length: 10' 7" (3.23 m), Boom: 21' 2" (6.45 m), Trackshoes: 24" (600 mm) triple grouser. JS370 NLC MONO



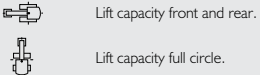











Load Point	Reach from Swing Center														Max Reach	
	4' 11" (1.5 m)		9' 10" (3 m)		14' 9" (4.5 m)		19' 8" (6 m)		24' 7" (7.5 m)		29' 6" (9 m)					
Height	 lb (kg)	 lb (kg)	 lb (kg)	 lb (kg)	 lb (kg)	 lb (kg)	 lb (kg)	 lb (kg)	 lb (kg)	 lb (kg)	 lb (kg)	 lb (kg)	 lb (kg)	 lb (kg)	ft-in (mm)	
24' 7" (7.5 m)										17350* (7870*)	15168 (6880)			14616* (6630*)	14418 (6540)	25-3 (7704)
19' 8" (6 m)										18276* (8290*)	15013 (6810)			14131* (6410*)	11839 (5370)	28-2 (8584)
14' 9" (4.5 m)								22421* (10170*)	20437 (9270)	19489* (8840*)	14462 (6560)	16777* (7610*)	10692 (4850)	14176* (6430*)	10406 (4720)	30-0 (9134)
9' 10" (3 m)					34811* (15790*)	28770 (13050)	25617* (11620*)	19092 (8660)	21098* (9570*)	13779 (6250)	17372 (7880)	10384 (4710)	14683* (6660*)	9656 (4380)	30-9 (9412)	
4' 11" (1.5 m)					39595* (17960*)	26587 (12060)	28351* (12860*)	17923 (8130)	22399 (10160)	13139 (5960)	17020 (7720)	10075 (4570)	15697* (7120*)	9348 (4240)	31-0 (9443)	
0' 0" (0 m)					40873* (18540*)	25617 (11620)	29806* (13520*)	17174 (7790)	21848 (9910)	12654 (5740)	16755 (7600)	9833 (4460)	16182 (7340)	9502 (4310)	30-3 (9229)	
-4' 11" (-1.5 m)			31041* (14080*)	31041* (14080*)	39551* (17940*)	25419 (11530)	29630* (13440*)	16843 (7640)	21605 (9800)	12434 (5640)			17372 (7880)	10163 (4610)	28-7 (8753)	
-9' 10" (-3 m)			48325* (21920*)	48325* (21920*)	36023* (16340*)	25662 (11640)	27513* (12480*)	16909 (7670)	21142* (9590*)	12522 (5680)			19136* (8680*)	11640 (5280)	26-1 (7965)	
-14' 9" (-4.5 m)			38338* (17390*)	38338* (17390*)	29520* (13390*)	26367 (11960)	22355* (10140*)	17416 (7900)					18585* (8430*)	14947 (6780)	22-2 (6757)	

















Notes:

- Lifting capacities are based on ISO 10567, that is: 75% of minimum tipping load or 87% of hydraulic lift capacity, whichever is the less. Lifting capacities marked* are based on hydraulic capacity.
- Lift capacities assume that the machine is on firm, level ground.
- Lift capacities may be limited by local regulations. Please refer to your dealer.















LIFT CAPACITIES – Dipper length: 13' 3" (4.03 m), Boom: 21' 2" (6.45 m), Trackshoes: 24" (600 mm) triple grouser. JS370 NLC MONO

Load Point	Reach from Swing Center														Max Reach		
	4' 11" (1.5 m)		9' 10" (3 m)		14' 9" (4.5 m)		19' 8" (6 m)		24' 7" (7.5 m)		29' 6" (9 m)						
Height															ft-in (mm)		
24' 7" (7.5 m)															11376* (5160*)	11376* (5160*)	28-2 (8601)
19' 8" (6 m)										16204* (7350*)	15278 (6930)	14925* (6770*)	11045 (5010)	11045* (5010*)	10163 (4610)	30-8 (9396)	
14' 9" (4.5 m)										17593* (7980*)	14661 (6650)	16270* (7380*)	10780 (4890)	11067* (5020*)	9039 (4100)	32-5 (9900)	
9' 10" (3 m)										19423* (8810*)	13867 (6290)	17174* (7790*)	10362 (4700)	11398* (5170*)	8400 (3810)	33-3 (10157)	
4' 11" (1.5 m)										21230* (9630*)	13073 (5930)	16909 (7670)	9921 (4500)	12103* (5490*)	8135 (3690)	33-4 (10185)	
0' 0" (0 m)										21671 (9830)	12456 (5650)	16512 (7490)	9568 (4340)	13206* (5990*)	8201 (3720)	32-8 (9988)	
-4' 11" (-1.5 m)	19114* (8670*)	19114* (8670*)	29013* (13160*)	29013* (13160*)	39947* (18120*)	24802 (11250)	29343* (13310*)	16424 (7450)	21230 (9630)	12059 (5470)	16292 (7390)	9370 (4250)	15013 (6810)	8642 (3920)	31-3 (9549)		
-9' 10" (-3 m)	29961* (13590*)	29961* (13590*)	41689* (18910*)	41689* (18910*)	37809* (17150*)	24780 (11240)	28329* (12850*)	16292 (7390)	21142 (9590)	11971 (5430)			16799 (7620)	9678 (4390)	29-0 (8835)		
-14' 9" (-4.5 m)	42835* (19430*)	42835* (19430*)	45547* (20660*)	45547* (20660*)	33091* (15010*)	25265 (11460)	25066* (11370*)	16557 (7510)	18717* (8490*)	12280 (5570)			17482* (7930*)	11773 (5340)	25-5 (7766)		

LIFT CAPACITIES – Dipper length: 7' 3" (2.21 m), Boom: 20' 0" (6.10 m), Trackshoes: 24" (600 mm) triple grouser. JS370 LC ME

Load Point	Reach from Swing Center														Max Reach				
	4' 11" (1.5 m)		9' 10" (3 m)		14' 9" (4.5 m)		19' 8" (6 m)		24' 7" (7.5 m)		29' 6" (9 m)								
Height															ft-in (mm)				
24' 7" (7.5 m)															23655* (10730*)	22729 (10310)	19-9 (6075)		
19' 8" (6 m)										23744* (10770*)	22994 (10430)				22487* (10200*)	17196 (7800)	23-5 (7163)		
14' 9" (4.5 m)										22487* (10200*)	15675 (7110)				22112* (10030*)	14661 (6650)	25-6 (7815)		
9' 10" (3 m)										28461* (12910*)	20878 (9470)	23236 (10540)	15190 (6890)		20481 (9290)	13448 (6100)	26-7 (8139)		
4' 11" (1.5 m)										30379* (13780*)	19952 (9050)	22729 (10310)	14705 (6670)		20040 (9090)	13051 (5920)	26-8 (8175)		
0' 0" (0 m)										30710* (13930)	19467 (8830)	22421 (10170)	14440 (6550)		20745 (9410)	13448 (6100)	26-0 (7926)		
-4' 11" (-1.5 m)										41270* (18720*)	41270* (18720*)	37633* (17070*)	29453* (13360)	28968* (13140*)	19400 (8800)		22377* (10150*)	14859 (6740)	24-2 (7364)
-9' 10" (-3 m)										38316* (17380*)	38316* (17380*)	31526* (14300*)	30005 (13610)	23920* (10850*)	19841 (9000)		21473* (9740*)	18254 (8280)	21-0 (6405)

LIFT CAPACITIES – Dipper length: 8' 8" (2.63 m), Boom: 21' 2" (6.45 m), Trackshoes: 24" (600 mm) triple grouser. JS370 LC ME



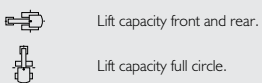











Load Point	Reach from Swing Center														Max Reach					
	4' 11" (1.5 m)		9' 10" (3 m)		14' 9" (4.5 m)		19' 8" (6 m)		24' 7" (7.5 m)		29' 6" (9 m)									
Height															ft-in (mm)					
24' 7" (7.5 m)															20459* (9280*)	19996 (9070)	21-7 (6607)			
19' 8" (6 m)										22399* (10160*)	22399* (10160*)	20966* (9510*)	16094 (7300)		19423* (8810*)	15653 (7100)	25-0 (7618)			
14' 9" (4.5 m)										30886* (14010*)	30886* (14010*)	24669* (11190*)	22266 (10100)	21539* (9770*)	15785 (7160)	19378* (8790*)	13536 (6140)	27-0 (8233)		
9' 10" (3 m)										37234* (16930*)	31879 (14460)	27535* (12490*)	21076 (9560)	22774* (10330*)	15234 (6910)	19026 (8630)	12478 (5660)	28-0 (8541)		
4' 11" (1.5 m)										41248* (18710*)	30005 (13610)	29828* (13530*)	20062 (9100)	22707 (10300)	14705 (6670)	18607 (8440)	12147 (5510)	28-1 (8575)		
0' 0" (0 m)										41446* (18800*)	29299 (13290)	30666* (13910*)	19445 (8820)	22333 (10130)	14352 (6510)	19180 (8700)	12456 (5650)	27-4 (8339)		
-4' 11" (-1.5 m)										29683* (18000*)	39683* (18000*)	38977* (17680*)	29255 (13270)	29542* (13400*)	19246 (8730)	22266 (10100)	14286 (6480)	21076 (9560)	13580 (6160)	25-6 (7807)
-9' 10" (-3 m)										43276* (19630*)	43276* (19630*)	33752* (15310*)	29674 (13460)	25706* (11660*)	19511 (8850)		20833 (9450*)	16226 (7360)	22-7 (6911)	
-14' 9" (-4.5 m)										23699* (10750*)	23699* (10750*)						18342* (8320*)	18342* (8320*)	17-9 (5468)	

















Notes:

- Lifting capacities are based on ISO 10567, that is: 75% of minimum tipping load or 87% of hydraulic lift capacity, whichever is the less. Lifting capacities marked* are based on hydraulic capacity.
- Lift capacities assume that the machine is on firm, level ground.
- Lift capacities may be limited by local regulations. Please refer to your dealer.















LIFT CAPACITIES – Dipper length: 7' 3" (2.21 m), Boom: 21' 2" (6.45 m), Trackshoes: 24" (600 mm) triple grouser. JS370 NLC ME

Load Point	Reach from Swing Center														Max Reach	
	4' 11" (1.5 m)		9' 10" (3 m)		14' 9" (4.5 m)		19' 8" (6 m)		24' 7" (7.5 m)		29' 6" (9 m)					
Height	 lb (kg)	 lb (kg)	 lb (kg)	 lb (kg)	 lb (kg)	 lb (kg)	 lb (kg)	 lb (kg)	 lb (kg)	 lb (kg)	 lb (kg)	 lb (kg)	 lb (kg)	 lb (kg)	ft-in (mm)	
24' 7" (7.5 m)							23633* (10720*)	21363 (9690)						23655* (10730*)	20900 (9480)	19-9 (6075)
19' 8" (6 m)							23744* (10770*)	21120 (9580)						22487* (10200*)	15807 (7170)	23-5 (7163)
14' 9" (4.5 m)					32915* (14930*)	30886 (14010)	25838* (11720*)	20194 (9160)	22487* (10200*)	17374 (6520)				22112* (10030*)	13448 (6100)	25-6 (7815)
9' 10" (3 m)							28461* (12910*)	19070 (8650)	23192 (10520)	13889 (6300)				20437 (9270)	13202 (5580)	26-7 (8139)
4' 11" (1.5 m)							30379* (13780*)	18166 (8240)	22663 (10280)	13448 (6100)				19974 (9060)	11927 (5410)	26-8 (8175)
0' 0" (0 m)					40895* (18550*)	26367 (11960)	30710* (13930*)	17681 (8020)	22355 (10140)	13184 (5980)				20701 (9390)	12280 (5570)	26-0 (7926)
-4' 11" (-1.5 m)			41270* (18720*)	41270* (18720*)	37633* (17070*)	26499 (12020)	28968* (13140*)	17615 (7990)						22377* (10150*)	13558 (6150)	24-2 (7364)
-9' 10" (-3 m)			38316* (17380*)	38316* (17380*)	31526* (14300*)	27028 (12260)	23920* (10850*)	18034 (8180)						21473* (9740*)	16645 (7550)	21-0 (6405)

LIFT CAPACITIES – Dipper length: 8' 8" (2.63 m), Boom: 21' 2" (6.45 m), Trackshoes: 24" (600 mm) triple grouser. JS370 NLC ME

Load Point	Reach from Swing Center														Max Reach	
	4' 11" (1.5 m)		9' 10" (3 m)		14' 9" (4.5 m)		19' 8" (6 m)		24' 7" (7.5 m)		29' 6" (9 m)					
Height	 lb (kg)	 lb (kg)	 lb (kg)	 lb (kg)	 lb (kg)	 lb (kg)	 lb (kg)	 lb (kg)	 lb (kg)	 lb (kg)	 lb (kg)	 lb (kg)	 lb (kg)	 lb (kg)	ft-in (mm)	
24' 7" (7.5 m)							21781* (9880*)	21737 (9860)						20459* (9280*)	18386 (8340)	21-7 (6607)
19' 8" (6 m)							22399* (10160*)	21363 (9690)	20966* (9510*)	14793 (6710)				19423* (8810*)	14396 (6530)	25-0 (7618)
14' 9" (4.5 m)					30886* (14010*)	30886* (14010*)	24699* (11190*)	20415 (9260)	21539* (9770*)	14484 (6570)				19378* (8790*)	12412 (5630)	27-0 (8233)
9' 10" (3 m)					37234* (16930*)	28836 (13080)	27535* (12490*)	19246 (8730)	22774* (10330*)	13933 (6320)				18982 (8610)	11420 (5180)	28-0 (8541)
4' 11" (1.5 m)					41248* (18710*)	27028 (12260)	29828* (13530*)	18254 (8280)	22663 (10280)	13426 (6090)				18563 (8420)	11089 (5030)	28-1 (8575)
0' 0" (0 m)					41446* (18800*)	26345 (11950)	30666* (13910*)	17637 (8000)	22266 (10100)	13073 (5930)				19136 (8680)	11354 (5150)	27-4 (8339)
-4' 11" (-1.5 m)			39683* (18000*)	39683* (18000*)	38977* (17680*)	26301 (11930)	29542* (13400*)	17460 (7920)	22200 (10070)	13007 (5900)				21010 (9530)	12390 (5620)	25-6 (7807)
-9' 10" (-3 m)			43276* (19630*)	43276* (19630*)	33752* (15310*)	26918 (12210)	25706* (11660*)	17725 (8040)						20833* (9450*)	14793 (6710)	22-7 (6911)
-14' 9" (-4.5 m)					23699* (10750*)	23699* (10750*)								18342* (8320*)	18342* (8320*)	17-9 (5468)

LIFT CAPACITIES – Dipper length: 7' 3" (2.21 m), Boom: 21' 2" (6.45 m), Trackshoes: 24" (600 mm) triple grouser. JS370 LC T.A.B.



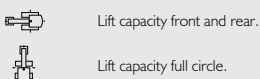











Load Point	Reach from Swing Center														Max Reach	
	4' 11" (1.5 m)		9' 10" (3 m)		14' 9" (4.5 m)		19' 8" (6 m)		24' 7" (7.5 m)		29' 6" (9 m)					
Height	 lb (kg)	 lb (kg)	 lb (kg)	 lb (kg)	 lb (kg)	 lb (kg)	 lb (kg)	 lb (kg)	 lb (kg)	 lb (kg)	 lb (kg)	 lb (kg)	 lb (kg)	 lb (kg)	ft-in (mm)	
24' 7" (7.5 m)					32716* (14840*)	32716* (14840*)	27425* (12440*)	23126 (10490)						26080* (11830*)	19378 (8790)	21-8 (6637)
19' 8" (6 m)					35097* (15920*)	35097* (15920*)	27976* (12690*)	22575 (10240)	23832* (10810*)	15697 (7120)				23148 (10500)	15168 (6880)	25-1 (7644)
14' 9" (4.5 m)							29387* (13330*)	21429 (9720)	23523 (10670)	15322 (6950)				20106 (9120)	13117 (5950)	27-1 (8257)
9' 10" (3 m)							30512* (13840*)	20172 (9150)	22884 (10380)	14749 (6690)				18695 (8480)	12125 (5500)	28-1 (8564)
4' 11" (1.5 m)							30137* (13670*)	19268 (8740)	22333 (10130)	14242 (6460)				18342 (8320)	11817 (5360)	28-2 (8598)
0' 0" (0 m)							27690* (12560*)	18827 (8540)	21627* (9810*)	13977 (6340)				17703* (8030*)	12169 (5520)	27-4 (8363)
-4' 11" (-1.5 m)					26367* (11960*)	26367* (11960*)	22972* (10420*)	18849 (8550)	17174* (7790*)	14065 (6380)				15190* (6890*)	13360 (6060)	25-7 (7833)



Notes:

- Lifting capacities are based on ISO 10567, that is: 75% of minimum tipping load or 87% of hydraulic lift capacity, whichever is the less. Lifting capacities marked* are based on hydraulic capacity.
- Lift capacities assume that the machine is on firm, level ground.
- Lift capacities may be limited by local regulations. Please refer to your dealer.

LIFT CAPACITIES – Dipper length: 7' 3" (2.21 m), Boom: 21' 2" (6.45 m), Trackshoes: 24" (600 mm) triple grouser. JS370 NLC T.A.B.

Load Point	Reach from Swing Center															
	4' 11" (1.5 m)		9' 10" (3 m)		14' 9" (4.5 m)		19' 8" (6 m)		24' 7" (7.5 m)		29' 6" (9 m)		Max Reach			
Height	 lb (kg)	 lb (kg)	 lb (kg)	 lb (kg)	 lb (kg)	 lb (kg)	 lb (kg)	 lb (kg)	 lb (kg)	 lb (kg)	 lb (kg)	 lb (kg)	 lb (kg)	 lb (kg)	ft-in (mm)	
24' 7" (7.5 m)					32716* (14840*)	32716* (14840*)	27425* (12440*)	21230 (9630)						26080* (11830*)	17769 (8060)	21-8 (6637)
19' 8" (6 m)					35097* (15920*)	32496 (14740)	27976* (12690*)	20679 (9380)	23832* (10810*)	14374 (6520)				23082 (10470)	13889 (6300)	25-1 (7644)
14' 9" (4.5 m)							29387* (13330*)	19577 (8880)	23457 (10640)	14021 (6360)				20062 (9100)	11993 (5440)	27-1 (8257)
9' 10" (3 m)							30512* (13840*)	18342 (8320)	22818 (10350)	13448 (6100)				18651 (8460)	11045 (5010)	28-1 (8564)
4' 11" (1.5 m)							30137* (13670*)	17438 (7910)	22266 (10100)	12963 (5880)				18298 (8300)	10758 (4880)	28-2 (8598)
0' 0" (0 m)							27690* (12560*)	17042 (7730)	21627* (9810*)	12698 (5760)				17703* (8030*)	11067 (5020)	27-4 (8363)
-4' 11" (-1.5 m)					26367* (11960*)	25860 (11730)	22972* (10420*)	17064 (7740)	17174* (7790*)	12765 (5790)				15190* (6890*)	12169 (5520)	25-7 (7833)



Lift capacity front and rear.



Lift capacity full circle.

Notes:

1. Lifting capacities are based on ISO 10567, that is: 75% of minimum tipping load or 87% of hydraulic lift capacity, whichever is the less. Lifting capacities marked* are based on hydraulic capacity.
2. Lift capacities assume that the machine is on firm, level ground.
3. Lift capacities may be limited by local regulations. Please refer to your dealer.







ONE COMPANY, MORE THAN 300 MACHINES.

Tracked Excavator JS330/370 LC/NLC

Net engine power: 281 hp (210 kW) Bucket capacity: 1.12 – 2.52 yd³
 Operating weight: 72691 – 85156 lb

JCB North America

2000 Bamford Blvd., Pooler, Georgia, 31322 Tel: (912) 447-2000
 Download the very latest information on this product range at www.jcb.com

JCB inc. All rights reserved. No part of this publication may be reproduced, stored in a retrieval system, or transmitted in any form or by any other means, electronic, mechanical, photocopying or otherwise, without prior permission from JCB inc. All references in this publication to operating weights, sizes, capacities and other performance measurements are provided for guidance only and may vary dependant upon the exact specification of machine. They should not therefore be relied upon in relation to suitability for a particular application. Guidance and advice should always be sought from your JCB Dealer. JCB reserves the right to change specifications without notice. Illustrations and specifications shown may include optional equipment and accessories. The JCB logo is a registered trademark of J C Bamford Excavators Ltd.

Your nearest JCB Dealer

9999/5994 en-US 02/17 Issue 1 (T4F) – DW USA 4510

 /JCBNA
  /JCBNA
  /JCBNORTHAMERICA

